

Price \$5.00

Cat. No. 63



C. SHERMAN JOHNSON CO. INC.  
**Johnson**

A tradition of innovation for over 60 years.



## 2021 MARINE HARDWARE CATALOG

Our complete inventory of life line fittings, rigging hardware and boating accessories is the first choice of boat designers, builders and owners everywhere.

FOR FULL 41 PAGE ARCHITECTURAL CATALOG  
FLIP TO BACK



[csjohnson.com](http://csjohnson.com)

**C. Sherman Johnson Company Inc.** was founded in 1958 by Curtiss S. Johnson Jr. (1925–2005). Curt's love of sailing inspired him to design and manufacture stainless steel turnbuckles, fittings and marine accessories for the pleasure marine market.

Many patents and innovative designs, such as the Handy Lock Turnbuckle, Hand Crimp Life Line Fittings and the Over Center Pelican Hook led Johnson Marine (Trade Name) to become one of the largest OEM suppliers of life line hardware in the marine industry.

Curt's sons, Burt and Curt Johnson, continue the tradition of innovation today, with the 3rd generation, Sam and Max, well involved in daily activities.



Curtiss S. Johnson Jr. (1925–2005)

**From all of us at JOHNSON... Thank you for your past, present and future business!  
We look forward to continuing to serve you.**

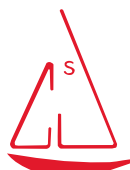

C. SHERMAN JOHNSON CO. INC.  
**Johnson**

A tradition of innovation for over 60 years.

Cover Photo: Ben on the Bow, Somewhere in the South Pacific aboard SV Verbena  
Photo by Bill Jacobson

Photos not to be reproduced without the expressed written consent of  
C. Sherman Johnson Co., Inc.

**LIFE LINE FITTINGS**

**PAGES 4-29**

Assuring onboard safety has always been of primary concern at Johnson Marine. We offer a complete line of life line fittings...turnbuckles, pelican hooks, gate eyes, toggle jaws, stanchion terminals, life line studs and much more.

Machine Swage Fittings . . . . . 6-15	Splice Line Fittings . . . . . 18-19
Gate Hooks . . . . . 7	Hand Crimp Fittings . . . . . 20-29
Turnbuckles . . . . . 8-9	Gate Hooks . . . . . 7, 21
Gate Eyes / Adjusters . . . . . 10-11	Turnbuckles . . . . . 22-23
Accessories / Replacement Parts . 12-15	Gate Eyes / Adjusters . . . . . 24-25
Xtreme Duty . . . . . 16	Accessories / Replacement Parts . 26-28
Machine Swaging Machines . . . . . 17	Hand Crimping Tools . . . . . 29



**RIGGING HARDWARE**

**PAGES 30-55**

At Johnson Marine we understand what is needed to rig dinghies up through large cruisers. Johnson offers a full line of studs, toggles, backstay/inner forestay turnbuckles, plates, pins and rings. Everything you need to rig and tune your boat safely.

Turnbuckles . . . . . 30-39	Stay Extenders/Adapter Plates . . . . . 46
Tie Down Hardware . . . . . 38-39, 41	Marine Eyes & Forks . . . . . 47
Stay Adjusters . . . . . 40-41	Toggle Jaws . . . . . 48
Quick Release Levers . . . . . 42	Turnbuckles Replacement Parts . . . 49-50
Inner Forestay Lever & Storage Bridle . 44	Rigging Pins . . . . . 53
Jack Line Fairlead . . . . . 44	Rigging Toggles . . . . . 54
Split Backstay Cars . . . . . 45	Sta-Lok Mechanical Fittings . . . . . 55



**BOATING ACCESSORIES**

**PAGES 56-65**

Johnson Marine's dynamic new packaging makes it easy for dealers to display the complete accessory line. Molded clear pack allows customer to visualize their purchase. Instructions are clearly and graphically displayed. Johnson offers many unique accessories to mount on rails, spars and decks.

Grab 'n Go Hook . . . . . 57	Rail Mount Accessories . . . . . 62-63
Wrap Pins . . . . . 58	Flag Halyards . . . . . 64
Rigger's Tape . . . . . 58	Sealube . . . . . 64
Chain Snubbers . . . . . 59	Sole Mate Ladder . . . . . 64
Cleats . . . . . 60, 63	Pin and Parts Kits . . . . . 65
Pad Eyes . . . . . 61	



**INDUSTRIAL TURNBUCKLES & FITTINGS**

**PAGES 66-69**

Johnson stainless steel turnbuckles and fittings have long been used in non-marine applications. Our latest offerings in eye, hook and jaw configurations are used where quality and esthetics are required. Quality 316 stainless is used throughout

Pad Eyes . . . . . 66	Eye-to-Eye . . . . . 68
Stainless Turnbuckles . . . . . 67-69	Eye-to-Jaw . . . . . 68
Eye-to-Hook . . . . . 67	Hook-to-Jaw . . . . . 69
Hook-to-Hook . . . . . 67	Jaw-to-Jaw . . . . . 69



# PEACE OF MIND

## C.S. JOHNSON LIFE LINE FITTINGS



Assuring onboard safety has always been of primary concern at Johnson Marine. We offer a complete line of life line fittings... turnbuckles, pelican hooks, gate eyes, toggle jaws, stanchion terminals, life line studs and much more - available in a selection of attachment styles to fit your needs:

- **Machine Swage**
- **DIY Hand Crimp**
- **No-Wire Splice Lines**

Johnson Marine products are made in the U.S.A. with the Johnson logo as your assurance of dependability.

- **Available in Splice Line, Extreme Duty, Machine Swage, Hand Crimp**
- **METS DAME Award Winning "Over Center" Pelican Hook**
- **All terminals machined from T-316 stainless steel**



## MACHINE SWAGE - REGULAR DUTY

These fittings have been the "Industry Standard" for over 50 years. Available for 1/8", 5/32", 3/16" and 1/4" wire sizes. Installed on boats from 18 to 45 feet as OEM equipment throughout North America and Canada. Machine swage is installed by professional riggers and builders using a roller swage type machine such as those shown on page 17. Over 50 years of proven reliability.

See pages 6-15



MACHINE  
MS  
SWAGE

## MACHINE SWAGE - EXTREME DUTY

Extreme Duty fittings were introduced by Johnson for 2003 to answer the needs of the larger 45 + cruising/offshore sailor. These fittings are beefier than standard duty and use 5/16" or larger components. Extreme Duty is available in 3/16" and 1/4" wire sizes. You'll achieve added peace of mind installing our Extreme Duty fittings. Larger wire size life line components have been known to pop-up over the years, don't hesitate to ask for a custom quote!

See page 16



EXTREME  
HD  
DUTY

## NO-WIRE SPLICE LINES

Hi-tech and low stretch for the DIY or professional. These fittings use an eye attachment with spliced Dyneema™ type line. This 12 strand, single braid is approximately 1/7 the weight and the same strength as comparable stainless steel wire. Several different colors are available giving your boat a custom look. Be sure to use our extra long (LS-92-150) turnbuckle designed just for our Splice Lines. Remember, UV is harsh! Change out your line every 4 years.

See pages 18-19



SPLICE  
SL  
LINE

## DO-IT-YOURSELF HAND CRIMP

Developed by Johnson during the mid-sixties for the DIY. Requires a special crimping tool sold by Johnson. See the hand crimp section for more info. If you're a good weekend handyman and understand hand tools, then you can replace your own life lines with confidence. These fittings will develop approximately 65% of the break strength of 7x7 wire and should not be used in high load or overhead or lifting situations.

See page 20-29

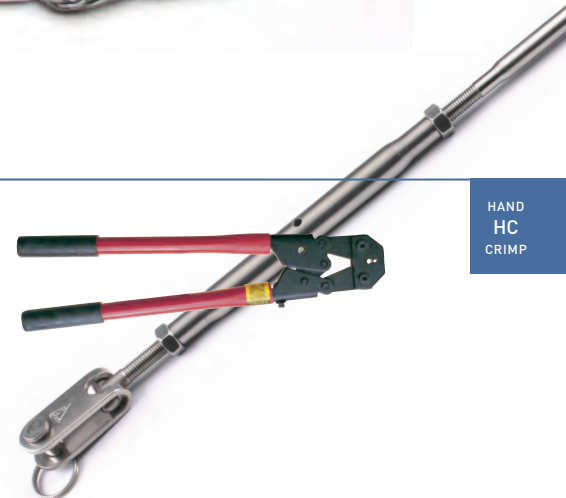

HAND  
HC  
CRIMP

*Not for lifting, hanging or other high load applications. See page 30 for Rigging Hardware.*

## MACHINE SWAGE LIFE LINE FITTINGS

Johnson Machine Swage Life Line Fittings are the ultimate in strength, durability and aesthetics, giving you complete peace of mind. Only a qualified, professional rigger can perform machine swaging. Life lines are generally swaged by way of a rotating set of cold forming dies or a hydraulic press with a minimum 60 tons of pressure. Our standard duty life line fittings match the strength of 7x7 coated or uncoated cable. 1x19 uncoated cable may also be used to meet the latest offshore rules. Either way, a life line system is like a big spring; the rails and stanchions will collapse well before the fittings or cable will fail. Be sure to specify JOHNSON, the world leader in innovation, design and quality for your next life line replacement.

MACHINE  
MS  
SWAGE

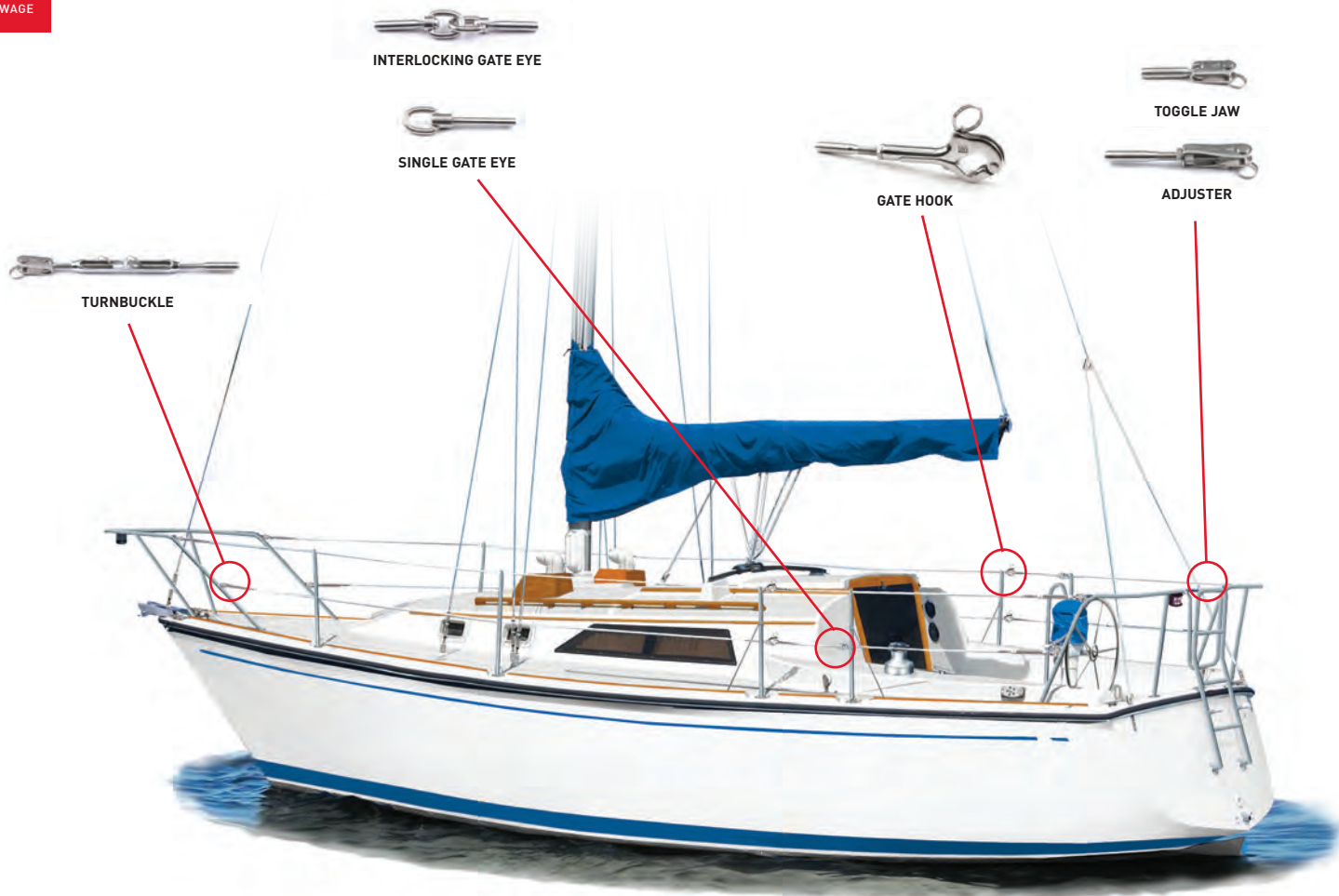

INTERLOCKING GATE EYE



SINGLE GATE EYE



GATE HOOK



TOGGLE JAW



ADJUSTER



TURNBUCKLE

## TYPICAL SAILBOAT LIFE LINE SETUP

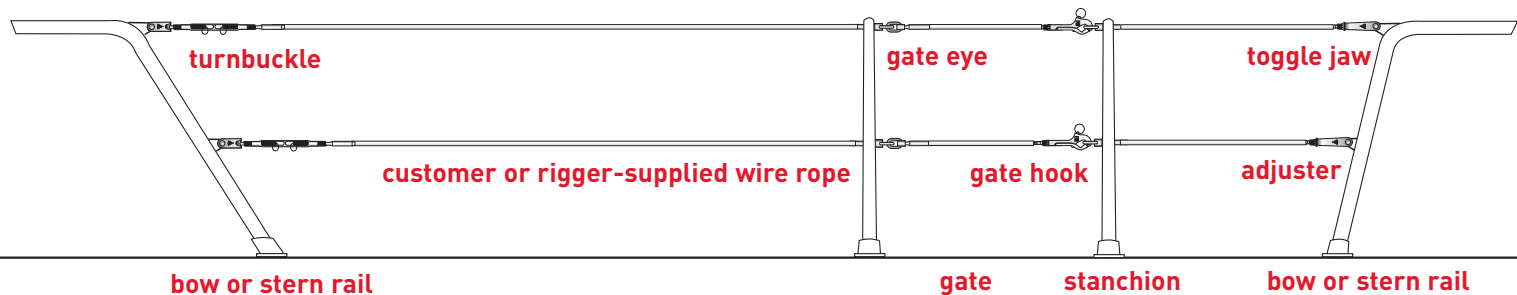

ALL TYPE 316 STAINLESS

PELICAN HOOKS

Snap Gate Hook



Body Only



Ring Only



Repair Kit

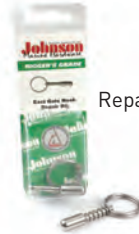

Replacement  
Terminals Pg 13



“Over Center” Snap Gate Hook

This is our latest and best design yet. Features the “over center” design with no load on the swinging hook when closed. This feature allows easy opening yet stays secure with a heavy split ring on the plunger latching device. Investment Cast T-316 Stainless. Patent Numbers DES, 421.892 US 6,237,927 B1

21-884	1/8" wire	1/4"-28 L.H.	1-1/4" adj.
21-885	5/32" wire	5/16"-24 L.H.	1-1/4" adj.
21-886	3/16" wire	5/16"-24 L.H.	1-1/4" adj.
21-888-7	1/4" wire	5/16"-24 L.H.	1-1/4" adj.

(21-888-7 uses 7/32" swage)

Snap Gate Hook - Body Only\*

For those that wish to replace their existing hooks - just match up the thread size. 3/2" long from end of body to inside bearing point of hook. Patent Numbers DES, 421.892 US 6,237,927 B1

21-80	5/16"-24 L.H.
21-80-1	5/16"-24 R.H.
21-81	1/4"-28 L.H.
21-88	8mm x 1.25 R.H.

\* Body Investment Cast in China

Snap Gate Hook Repair Kit

21-850	Repair Kit for lost or worn latching mechanisms
R-4	Ring Only

MACHINE  
MS  
SWAGE

Mini Snap Gate Hook - “Over Center”

Our new Mini Snap Gate Hook features our same “Over-Center” design as our larger snap gate hook. This feature allows easy opening and closing with no load on the swinging hook when closed. Ideal for lower life lines and powerboats. 2-3/4" grip length, 3" overall. Investment Cast T-316 Stainless.

21-784	1/8" wire	1/4"-28 L.H.	1" adj.
21-785	5/32" wire	1/4"-28 L.H.	1" adj.
21-786	3/16" wire	1/4"-28 L.H.	1" adj.
21-71	Body Only	1/4"-28 L.H.	1" adj.
21-750	Repair Kit for lost or worn latching mechanisms		

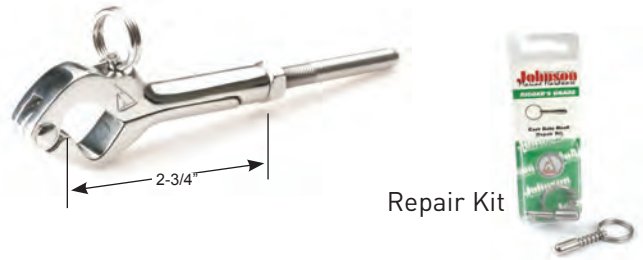

Repair Kit

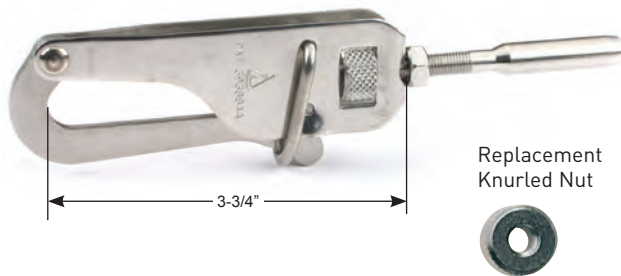

Replacement  
Knurled Nut

Safe Lock Gate Hook

Stainless, safe, inexpensive design *Practical Sailor* called a “well engineered hunk of metal”. Adjusts in place with knurled nut, stamped metal construction - 3 3/4" long from end of body to inside bearing point of hook.

23-301	1/8" wire	1/4"-28 L.H.	1 1/4" adj
24-304	5/32" wire	1/4"-28 L.H.	1 1/4" adj
24-301	3/16" wire	1/4"-28 L.H.	1 1/4" adj
35-622	Replacement Knurled Nut		

Tubular Gate Hook

Inexpensive, slender tubular design with a stamped hook. 4 3/4" long from end of body to inside bearing point of hook.

21-304	1/8" wire	1/4"-28 L.H.	1 1/2" adj
21-305	5/32" wire	1/4"-28 L.H.	1 1/2" adj
21-306	3/16" wire	1/4"-28 L.H.	1 1/2" adj

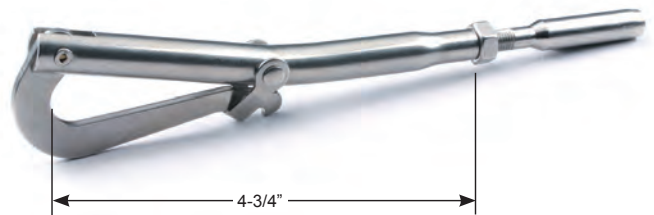

BRONZE BODY / 316 STAINLESS

**OPEN BODY TURNBUCKLE**

**Jaw to Swage**

Classic, traditional design. Forged silicon bronze body with T-316 stainless ends.

42-314	Chrome	1/8" wire 1/4" pin	3" adj
42-315	Chrome	5/32" wire 1/4" pin	3" adj
42-316	Chrome	3/16" wire 1/4" pin	3" adj
43-318-7	Chrome	1/4" wire 5/16" pin	3" adj
44-318	Chrome	1/4" wire 3/8" pin	4" adj

(43-318-7 uses 7/32" swage)



MACHINE  
MS  
SWAGE

ALL TYPE 316 STAINLESS

**TUBULAR TURNBUCKLE**

**Jaw to Swage - Check Nut Locking**

Our most popular life line turnbuckle. Check nut locking.

19-314-2	1/8" wire	3/16" pin	2-1/2" adj
19-314*	1/8" wire	1/4" pin	3" adj
19-315*	5/32" wire	1/4" pin	3" adj
19-316*	3/16" wire	1/4" pin	3" adj
19-308	1/4" wire	3/8" pin	4-1/4" adj
19-318-7	1/4" wire	5/16" pin	3-3/4" adj

(19-318-7 uses 7/32" die) \* add "S" for Shortie version.



ALL TYPE 316 STAINLESS

**TUBULAR TURNBUCKLE**

**Eye to Swage - Check Nut Locking**

Used where an eye is required for attachment instead of a jaw- check nut locking.

20-304*	1/8" wire	3" adj
20-305*	5/32" wire	3" adj
20-306*	3/16" wire	3" adj
20-308	1/4" wire	4-1/4" adj
20-308-7	1/4" wire	4" adj

\* add "S" for Shortie version. (20-308-7 uses 7/32" swage)



ALL TYPE 316 STAINLESS

**TUBULAR SLOTTED TURNBUCKLE**

**Jaw to Swage - Positive Locking Rings**

Unique design features a slot with wraparound rings which fit through a cross-hole in terminal for secure locking.

19-324	1/8" wire	1/4" pin	2-7/8" adj
19-325	5/32" wire	1/4" pin	2-7/8" adj
19-326	3/16" wire	1/4" pin	2-7/8" adj
36-605		Locking Ring for above	
19-328	1/4" wire	3/8" pin	3-1/4" adj
36-602		Locking Ring for above	



36-602/605





ALL TYPE 316 STAINLESS

### SMOOTH LINE TURNBUCKLE

Closed Thread

Very popular architectural turnbuckle also great for life lines. No exposed threads. Cable termination is hidden inside of body and rotates on threaded cap. For details see page 5 of ARCHITECTURAL section.



Swage Sleeve



Life Line Fittings are not designed for lifting, hanging or other high load applications.  
See page 30 for Rigging Hardware.

60-700	1/8" wire	1/4" pin	2" adj
60-701	5/32" wire	1/4" pin	2" adj
60-702	3/16" wire	1/4" pin	2" adj
60-704	1/4" wire	5/16" pin	2" adj

#### Smooth Line Replacement Parts

60-610	Nose Cone- 1/8"	60-613	Swage Sleeve- 1/8"
60-610-1	Nose Cone- 5/32"	60-620	Swage Sleeve-5/32"
60-611	Nose Cone- 3/16"	60-612	Swage Sleeve- 3/16"
60-611-1	Nose Cone- 1/4"	60-612-1	Swage Sleeve- 1/4"

MACHINE  
MS  
SWAGE

BRONZE / 316 STAINLESS

### ADJUSTER TURNBUCKLE

Jaw to Swage

Stamped, strap design turnbuckle with Knurled nut for adjustment.



35-623/624

23-302	1/8" wire	3/16" pin	2" adj
35-623	Replacement Knurled Nut for above		
24-302	3/16" wire	1/4" pin	2-3/4" adj
35-624	Replacement Knurled Nut for above		

ALL TYPE 316 STAINLESS

### DECK TOGGLE TURNBUCKLE

Deck to Swage

This "T" bolt style fitting is used on decks or bulkheads. Toggle nut style also available to match old style.



Not for lifting, hanging or other high load applications.  
See page 30 for Rigging Hardware.

Turnbuckle replacement parts on pages 13-15

19-314-1T*	1/8" wire	1/4"-28	3" adj
19-315-1T*	5/32" wire	1/4"-28	3" adj
19-316-1T*	3/16" wire	1/4"-28	3" adj
19-318-1T	1/4" wire	5/16"-24	3" adj

(19-318-1T uses 7/32" swage)  
\* add "S" for Shortie version.

#### Techno•TIP

One of the most neglected parts on a sailboat are the Life Line and Rigging Turnbuckles. Turnbuckles need to be kept free of dirt and salt by rinsing with fresh water periodically. A good marine lubricant like Johnson Sealube or equivalent should be applied to the threads. The lubricant will provide corrosion protection and keep the turnbuckles turning freely. Never straighten a bent threaded stud, always replace it. A bent stud is considerably weakened.

ALL TYPE 316 STAINLESS

### Single Gate Eye - Swivel

A single eye is used on one end of the gate area to attach the gate hook.



22-311	1/8" wire
22-317	5/32" wire
22-313	3/16" wire

### Single Gate Eye - Threaded

Same as above only terminal is threaded into eye nut.



22-301	1/8" wire
22-307	5/32" wire
22-303	3/16" wire
22-305-7	1/4" wire 7/32" swage
22-305	1/4" wire

Do not swage with Wire Teknik Machine

### Interlocking Gate Eye - Swivel

An interlocking gate eye is used at the opposite end of the gate hook as a "hinge" for the gate.



22-312	1/8" wire
22-318	5/32" wire
22-314	3/16" wire

### Interlocking Gate Eye - Threaded

Same as above only terminal is threaded into eye nut.



22-302	1/8" wire
22-308	5/32" wire
22-304	3/16" wire
22-306-7	1/4" wire 7/32" swage
22-306	1/4" wire

Do not swage with Wire Teknik Machine

### Eye-to-Eye Fitting

This fitting can be used wherever an eye is required on each side of the stanchion.

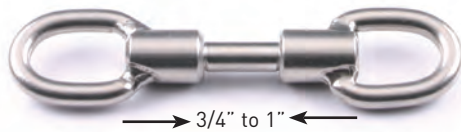

22-100	Adjustable between 3/4" and 1"
--------	--------------------------------

### Eye-to-Interlocking Gate Eye Fitting

This fitting can be used wherever an eye is required on one side, and an interlocking eye on the other side of a stanchion.



22-304-100*	Adjustable between 3/4" and 1"
-------------	--------------------------------

\* Add -L for 1-1/4"

### Deck Toggle - Old Style

This fitting can be used wherever a cable needs to be terminated to a deck or bulkhead.



25-305-1	5/32" wire "old style"
----------	------------------------

### Deck Toggle - 'T' Style

Same Deck Toggle only "T" bolt construction.



25-314-1T	1/8" wire "T-style"
25-315-1T	5/32" wire "T-style"
25-316-1T	3/16" wire "T-style"
25-318-1T	1/4" wire "T-style" 7/32" swage

MACHINE  
MS  
SWAGE

### Adjuster - Short

Generally used at the stern rail in conjunction with the single gate eye to tension that section of the gate.



23-303	1/8" wire 1/4" pin	1" adj
24-305	5/32" wire 1/4" pin	1" adj
35-620	Knurled Nut for 1/8", 5/32" size	
24-303	3/16" wire 1/4" pin	1" adj
35-621	Knurled Nut for 3/16", 1/4" size	
24-308-7	1/4" wire 1/4" pin	1" adj

### Toggle Jaw, "T" Style

Generally used at the stern rail when no gate is required with a turnbuckle forward.



25-314	1/8" wire 1/4" pin
25-315	5/32" wire 1/4" pin
25-316	3/16" wire 1/4" pin
25-318-7	1/4" wire 5/16" Pin 7/32" swage

Do not swage with Wire Teknik Machine

MACHINE  
MS  
SWAGE

### Toggle Jaw, Old Style

Same as above only uses toggle nut style instead of "T" bolt style.



25-304	1/8" wire 1/4" pin
25-305	5/32" wire 1/4" pin
25-306	3/16" wire 1/4" pin
25-308	1/4" wire 3/8" pin
25-308-7	1/4" wire 5/16" pin 7/32" swage

### Eye to Jaw Fitting

This fitting will convert a small bail at the stern rail to our standard gate eye to accept our Over Center Gate Hook.

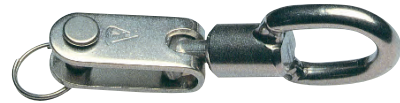

Eye to Jaw	Cat. No. LS-2500
------------	------------------

### Eye to Deck Toggle Fitting

This fitting can be mounted to any flat surface and accept life line fittings, line, etc. Toggling action is 140 degrees.



Eye to Deck Toggle	Cat. No. LS-2550
--------------------	------------------

### Gate Eye to Stud with Button

These fittings can be used wherever a single or double gate eye is needed on one side of a stanchion.



22-304-10FS*	Adjustable between 3/4" and 1"
22-303-10FS*	Adjustable between 3/4" and 1"

\* Add -L for 1-1/4"

*Not for lifting, hanging or other high load applications. See page 30 for Rigging Hardware.*

ALL TYPE 316 STAINLESS

### Stanchion Eye

1" Stanchion



This fitting is used on a stanchion for adding lower life lines without the need to drill holes for the cable to pass through. (5/16" hole).

Stanchion Eye Cat. No. 29-502

### Pulpit Anchor

1" Rail



Can be used on the stern rail and bow pulpit to terminated jaw fittings for lower (or upper) life lines. (1/2" hole). Hole will not accept cast gate hooks.

Pulpit Anchor Cat. No. 29-501

MACHINE MS SWAGE

### Diamond Pad Eye

1/4" Bail

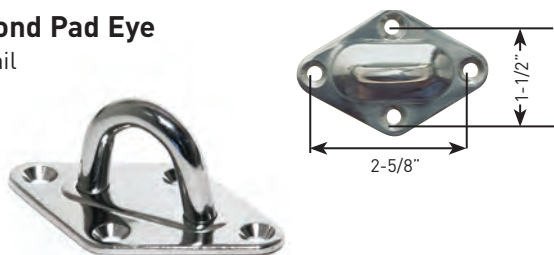

This pad eye can be used on deck for life lines or other applications. 750 lbs safe working load. See our hinged pad eyes on page 61 and/or 66.

Diamond Pad Eye Cat. No. 28-501

### Stanchion Terminal



Used where the cable needs to be terminated at the stanchion.

a	25-304-5F	1/8" wire
a	25-305-5F	5/32" wire
a	25-306-5F	3/16" wire
a	25-308-7-5F	1/4" wire (7/32" die)
b	100-110-1	1/8" wire (true 1/8" terminal)

### Gate Stop

These collars can be used at the gate instead of interlocking eyes, they maintain tension while the gate is open. A set-screw holds them in place.

	29-507	1/8" max inside diameter
	29-503	3/16" max inside diameter
	29-503-1	5/32" max inside diameter
	29-504	1/4" max inside diameter
	29-505	5/16" max inside diameter
	29-506	3/8" max inside diameter

### Gate Eye - No Stud



\* Note - add -12 for RH

22-301-P	1/4-28 L.H.	Single Eye - 1/8" wire
22-303-P	5/16-24 L.H.	Single Eye - 3/16" wire
22-305-P	3/8-24 L.H.	Single Eye - 1/4" wire
22-302-P	1/4-28 L.H.	Intlkg Eye - 1/8" wire
22-304-P	5/16-24 L.H.	Intlkg Eye - 3/16" wire
22-306-P	3/8-24 L.H.	Intlkg Eye - 1/4" wire

### Terminal to Terminal Fitting



Used whenever two pieces of cable need to be joined.

25-316-5-6 Swage to Swage Stud 3/16"

### Conversion Sleeve - Nickel Brass

Allows the use of 3/16" life line fittings to be used with 1/8" cable. Slide over cable first then into fitting.



36-610 1/8 to 3/16" Machine Swage

ALL TYPE 316 STAINLESS

## Threaded Life Line Terminals for Machine Swaging

*Not for lifting, hanging or other  
high load applications.  
See page 30 for Rigging Hardware.*



CATALOG NUMBER	THREAD SIZE	WIRE SIZE	CAT # USED ON
30-601	1/4-28 L.H. x 3/8	1/8"	22-301 & 302
30-602	1/4-28 L.H. x 1-1/2	1/8"	23-303 & 21-784
30-602-1	1/4-28 R.H. x 1-1/2	1/8"	Full Thread Terminal Tuners, "S" Series
30-603	1/4-28 L.H. x 2-1/2	1/8"	20-304, 21-304, 19-314 & 21-884
30-603-1	1/4-28 R.H. x 2 1/2	1/8"	GENERAL
Δ 30-603-1TT	1/4-28 R.H. x 3/8	1/8"	Blind Thread Terminal Tuners
30-604	10-32 R.H. x 3	1/8"	23-302
30-604-1	10-32 L.H. x 1-7/8	1/8"	19-314-2
30-605***	1/4-28 L.H. x 2-1/2	1/8"	23-301, 19-324, 42-314
30-621	1/4-28 L.H. x 2-1/2	5/32"	19-315-2, 325, 21-305, 24-304, 42-315
30-621-1	1/4-28 R.H. x 2-1/2	5/32"	19-315-2, SPECIAL
30-622	1/4-28 L.H. x 3/8	5/32"	22-307 & 22-308
30-623	1/4-28 L.H. x 1-1/2	5/32"	24-305
30-623-1	5/16-24 L.H. x 2	5/32"	21-413, 21-885
30-606*	5/16-24 L.H. x 3/8	3/16"	22-303 & 304
30-607*	5/16-24 L.H. x 2	3/16"	21-886, 24-303
30-607-1*	5/16-24 R.H. x 2	3/16"	GENERAL
30-608*	1/4-28 L.H. x 2-1/2	3/16"	20-306, 21-306, 19-316
30-608-1*	1/4-28 R.H. x 2-1/2	3/16"	SPECIAL "S" Series
30-608S	1/4-28 L.H. x 1-1/2	3/16"	21-786, "S" Series
Δ 30-608-1TT	1/4-28 R.H. x 3/8	3/16"	Blind Thread Terminal Tuners
30-608-1S	1/4-28 R.H. x 1-1/2	3/16"	Full Thread Terminal Tuners, "S" Series
30-609*	1/4-28 R.H. x 3-3/4	3/16"	GENERAL
30-610***	1/4-28 L.H. x 2-1/2	3/16"	24-301, 19-326, 42-316
30-611	3/8-24 L.H. x 3/8	1/4"	22-305, 306
30-611-7**	5/16-24 L.H. x 3/8	1/4"	22-305/6-7
30-612	3/8-24 L.H. x 1-1/2	1/4"	GENERAL
30-612-2-7*	5/16-24 L.H. x 2	1/4"	21-888-7, 24-308-7
30-613	3/8-24 L.H. x 3	1/4"	GENERAL
30-613-1	3/8-24 R.H. x 3	1/4"	GENERAL
30-613-7**	3/8-24 L.H. x 3	1/4"	GENERAL
30-613-1-7**	3/8-24 R.H. x 3	1/4"	GENERAL
30-615**	5/16-24 L.H. x 2-3/4	1/4"	GENERAL
30-615-1**	5/16-24 R.H. x 2-3/4	1/4"	GENERAL
30-615-1S**	5/16-24 R.H. x 1-1/2	1/4"	Full Thread Terminal Tuners, "S" Series
Δ 30-615-1TT**	5/16-24 R.H. x 1/2	1/4"	Blind Thread Terminal Tuners
25-304-5	1/4-28 RH x 3/8	1/8"	Special and 25-304-5F/B
25-306-5	1/4-28 RH x 3/8	3/16"	Special and 25-306-5F/B
25-308-7-5**	5/16-24 RH x 1/2	1/4"	Special and 25-308-7-5F/B

MACHINE  
MS  
SWAGE

\* Note - 3/16" terminals may be used for 1/8" wire - Order #36-610 sleeve

\*\* Note - These studs must be swaged using a 7/32" die

\*\*\* Note - Cross drilled

Δ Note - Cannot swage with WireTeknik Swaging Machines.

TYPE 316 STAINLESS / Silicon Bronze

### Replacement Turnbuckle Bodies

LIFELINE FITTINGS



Use for Life Line or Rigging Applications.

CAT. NO.	THREAD SIZE	OVERALL LENGTH	STYLE
34-601	10-32	3-1/2"	Tubular
34-602	1/4-28	4-1/2"	Tubular
34-602 S	1/4-28	3"	Tubular-Shortie
34-603	5/16-24	5-1/4"	Tubular
34-604	5/16-24	5-1/4"	Tubular-Slotted
34-605	3/8-24	5-1/2"	Tubular
34-606	3/8-24	5-1/2"	Tubular-Slotted
34-607	1/2-20	7"	Tubular-Slotted
34-608	5/8-18	8-1/2"	Tubular-Slotted
34-609	1/4-28	4-1/2"	Tubular-Slotted
34-610	1/4-28	4-1/2"	Open Body
34-611	5/16-24	4-7/8"	Open Body
34-612	3/8-24	5-1/4"	Open Body
34-613	1/2-20	6-1/2"	Open Body
34-614	5/8-18	7-3/4"	Open Body
34-607-2	1/2-20	7"	Tubular
34-608-2	5/8-18	8-1/2"	Tubular

ALL TYPE 316 STAINLESS

### Replacement Turnbuckle / Deck Toggle Jaws

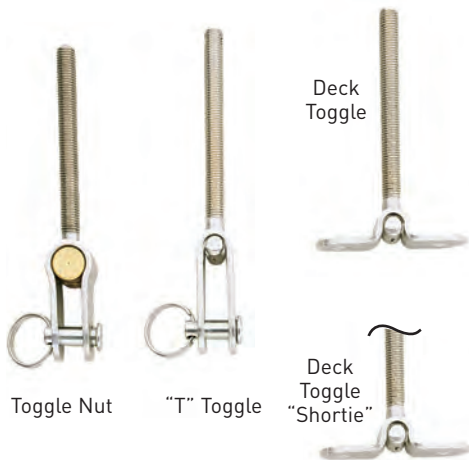

Use for Life Line or Rigging Applications.

CAT. NO.	THREAD SIZE	STYLE	CAT. NO.	THREAD SIZE	STYLE
33-601*	10-32 R.H.	T TOGGLE	33-617	5/16-24R.H.	T TOGGLE
33-602*	10-32 L.H.	T TOGGLE	33-618	5/16-24 L.H.	T TOGGLE
33-615	1/4-28 R.H.	T TOGGLE	33-617-1	5/16-24 R.H.	DECK TOGGLE
33-616	1/4-28 L.H.	T TOGGLE	33-618-1	5/16-24 L.H.	DECK TOGGLE
33-605	1/4-28 R.H.	TOGGLE NUT	33-619	3/8-24 R.H.	T TOGGLE
33-606	1/4-28 L.H.	TOGGLE NUT	33-620	3/8-24 L.H.	T TOGGLE
33-607	5/16-24R.H.	TOGGLE NUT	33-611	1/2-20 R.H.	TOGGLE NUT
33-608	5/16-24 L.H.	TOGGLE NUT	33-612	1/2-20 L.H.	TOGGLE NUT
33-609	3/8-24 R.H.	TOGGLE NUT	33-613	5/8-18 R.H.	TOGGLE NUT
33-610	3/8-24 L.H.	TOGGLE NUT	33-614	5/8-18 L.H.	TOGGLE NUT
33-615-1	1/4-28 R.H.	DECK TOGGLE	33-603**	1/4-28 R.H.	BCKSTY ADJ.
33-616-1	1/4-28 L.H.	DECK TOGGLE	33-604**	1/4-28 L.H.	BCKSTY ADJ.
33-615S*	1/4-28 R.H.	SHORTIE			
33-616S*	1/4-28 L.H.	SHORTIE			

\* Also available in Deck Toggle Style.  
 \*\* For 01 Series Backstay Adjuster Only  
 (Includes Square Nut)

All Toggle Jaws can be used for life line and rigging applications.  
 Deck Toggles are used for Life line and Architectural applications only.

ALL TYPE 316 STAINLESS

Replacement Locking Nuts

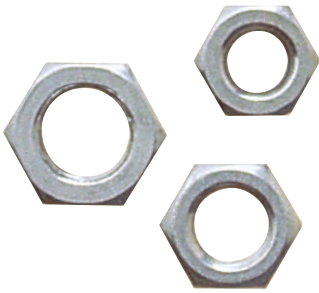

CAT. NO.	THREAD SIZE	CAT. # USED ON	CAT. NO.	THREAD SIZE	CAT. # USED ON
35-601	10-32 R.H.	03 & 11	35-608	3/8-24 L.H.	06 & 08
35-602	10-32 L.H.	03	35-609	1/2-20 R.H.	General
35-603	1/4-28 R.H.	04 & 19	35-610	1/2-20 L.H.	General
35-604	1/4-28 L.H.	04, 19 & 21	35-611	5/8-18 R.H.	General
35-605	5/16-24 R.H.	05 & 07	35-612	5/8-18 L.H.	General
35-606	5/16-24 L.H.	05 & 07			
35-607	3/8-24 R.H.	06 & 08			

LIFELINE FITTINGS

See full strength nuts on page 33 ARCHITECTURAL side of the catalog.

Nickel Plated Bronze

Replacement Knurled Nuts

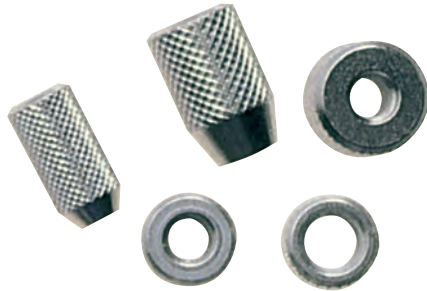

CAT. NO.	THREAD SIZE	DESCRIPTION	SERIES USED ON
35-620	1/4-28 L.H.	ADJUSTER	23-303, 406
35-621	5/16-24 L.H.	ADJUSTER	24-303, 27-406
35-622	1/4-28 L.H.	PELICAN HOOK	23/24-301, 26/27-404
35-623	10-32 R.H.	TURNBUCKLE	23-302/11 SER
35-624	1/4-28 R.H.	TURNBUCKLE	24-302/12 SER

PEACE OF MIND

For over 60 years Johnson has been giving boaters peace of mind by providing the highest quality life line hardware for boats of all sizes. Inspect your life lines annually and when its time to replace, rest assured you can count on the quality of Johnson.

photo courtesy of Karen Kelley

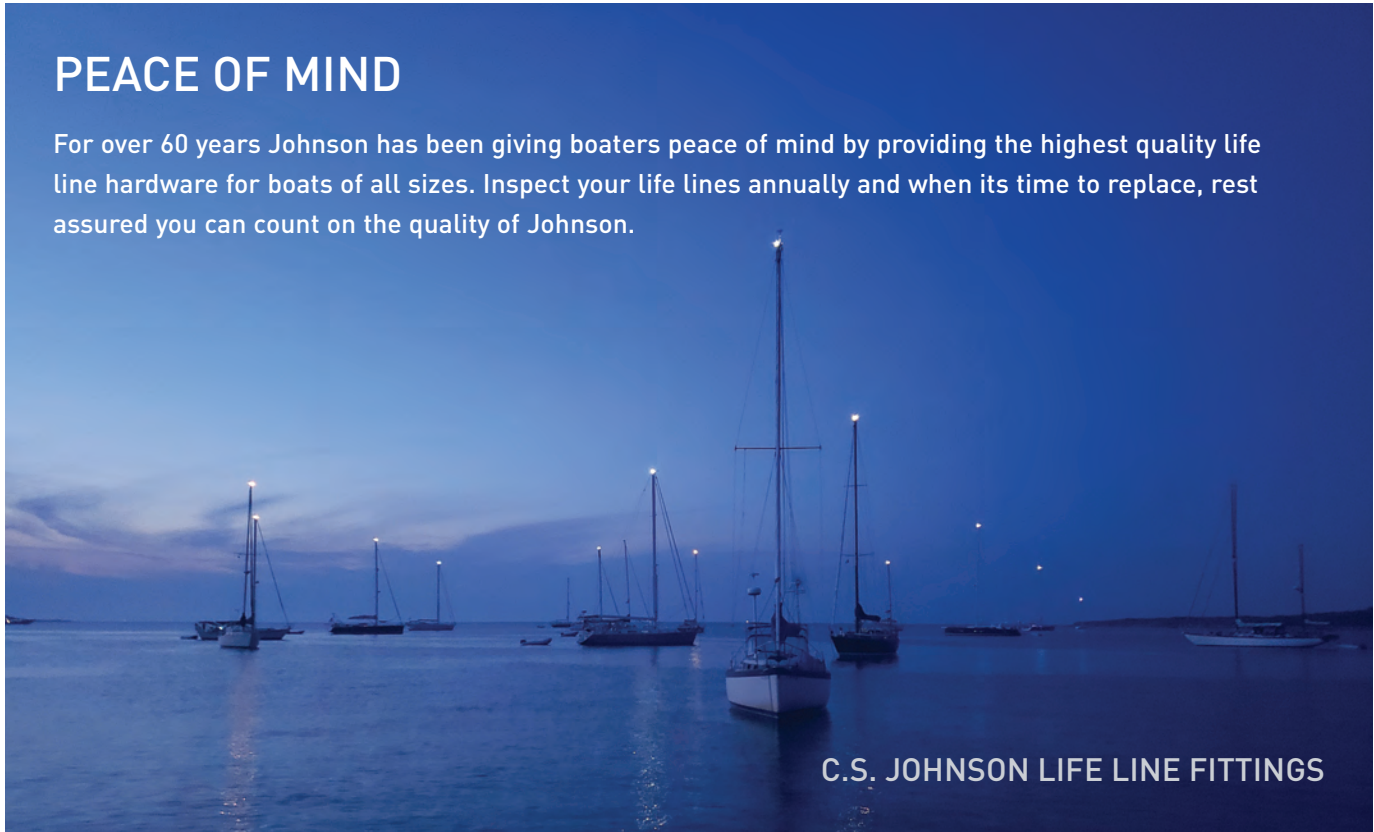

C.S. JOHNSON LIFE LINE FITTINGS

ALL TYPE 316 STAINLESS

## THE ULTIMATE FOR SERVICE AND RELIABILITY

Johnson "Extreme Duty" Offshore Series Life Line Fittings were developed with the discriminating offshore sailor in mind. Extreme duty fittings compromise nothing. Install peace of mind when specifying Johnson Extreme Duty fittings.

- Full length wire engagement terminals.
- 5/16" and 3/8" threads only, no 1/4" threads.
- For 3/16" and 1/4" coated or uncoated cable.
- All fittings are T-316 Stainless Steel.
- All T-bolt style fittings.



EXTREME  
HD  
DUTY



MACHINE  
MS  
SWAGE

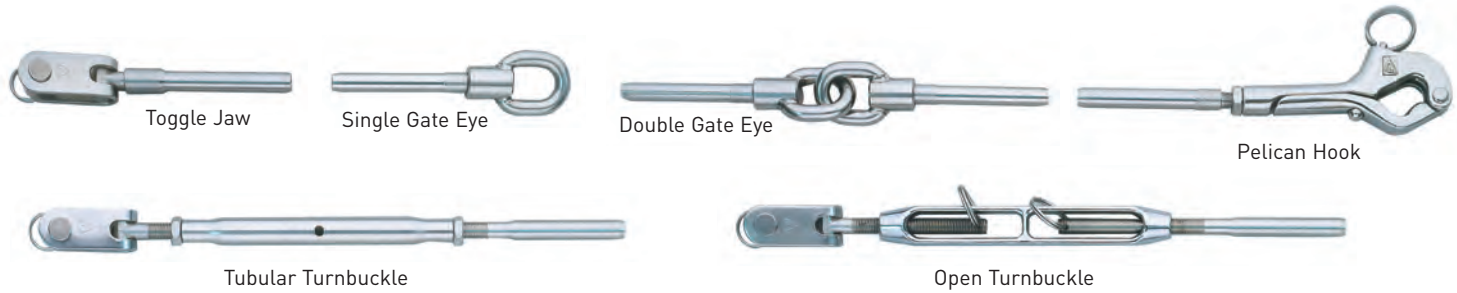

### 3/16" Wire Offshore Series Fittings

CAT. NO.	DESCRIPTION	SIZE
22-303EX	Single Gate Eye	5/16" bail, 3/8" thread
22-304EX	Double Gate Eye	5/16" bail, 3/8" thread
05-116EX	Tubular Turnbuckle	5/16" pin & thread
43-116EX	Open Turnbuckle	5/16" pin & thread
17-216	Toggle Jaw	5/16" pin
21-886EX*	Pelican Hook	5/16" thread, LH

### 1/4" Wire Offshore Series Fittings

CAT. NO.	DESCRIPTION	SIZE
22-305EX	Single Gate Eye	5/16" bail, 3/8" thread
22-306EX	Double Gate Eye	5/16" bail, 3/8" thread
06-118EX	Tubular Turnbuckle	3/8" pin & thread
44-118EX	Open Turnbuckle	3/8" pin & thread
25-318EX	Toggle Jaw	3/8" pin
21-888EX*	Pelican Hook	5/16" thread, LH

\* Body Investment Cast in China



## SWAGING MACHINES

### Portable Hydraulic Press Swager - by Johnson

This swager now features a more user friendly, spring loaded die set for easier re-load and better die alignment. The included die set will swage 1/8" and 3/16" terminals. All that is required is 100 psi of compressed air which is coupled to an air over hydraulic foot switch. An electric over hydraulic pump can also be used as an option. Not rated or certified for mil-spec applications such as aircraft control cables or marine standing rigging, perfect for architectural cable rail terminals and marine life line terminals.

**Swaging range:**  
1/8" & 3/16"

**Dimensions:**  
L 7"  
W 5 1/2"  
H 13"

**Shipping Weight:**  
50 lbs

**Cat No:**  
HLS2 - Swager and Case Only



MACHINE  
MS  
SWAGE

### Locoloc® Bench Swager - Type II

A sophisticated swaging machine which is bench mounted for easy operation. This swaging machine will accomplish the swaging of AN or MS type fittings on all galvanized and stainless steel cable up to and including 3/8" diameter. Available in hand crank manual or powered versions.

#### Requires (at least one of these):

- Air/Hand Pump
- Air/Hydraulic Foot Switch
- Electric/Hydraulic Pump

#### M2 Manual / M2-P Power

Swaging range:  
1/16" - 3/8"

Dimensions:  
L 12"  
W 9"  
H 12"

Shipping Weight:  
175 lbs (manual)  
275 lbs (power)

Made in USA  
**Makes Mil-Spec Swages**

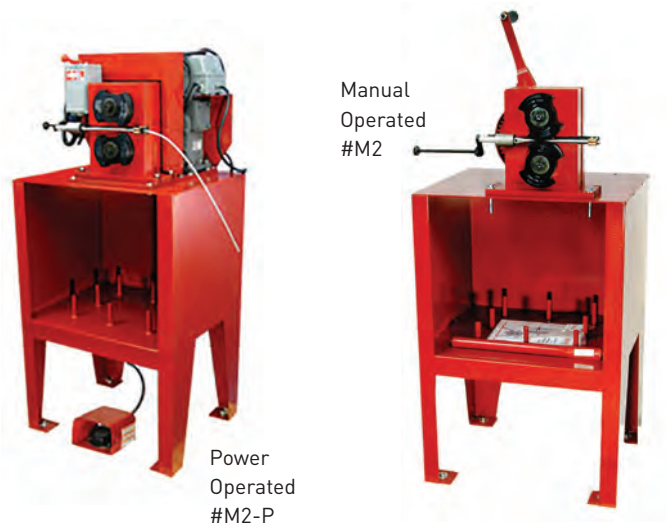

### WireTeknik™ Roller Swagers

Made in Sweden - Makes Mil Spec Swages

NOTE: Cannot swage Smooth Line Turnbuckles, Blind Thread Terminal Tuners and 1/8" Terminator Turnbuckles. Adapter needed for deck toggles. All Wireteknik swaging machines and accessories/replacement parts are available through Johnson.



A100

#### A100

Swaging range:  
1/16" - 3/16"

Dimensions:  
L 19 3/4"  
W 11 3/4"  
H 4"

Shipping Weight:  
50 lbs

#### A200

Swaging range:  
1/16" - 5/16"

Dimensions:  
L 17"  
W 11"  
H 4 3/4"

Shipping Weight:  
100 lbs

#### A270

Swaging range:  
3/32" - 1/2"

Dimensions:  
L 37"  
W 15 3/8"  
H 6 9/32"

Shipping Weight:  
150 lbs

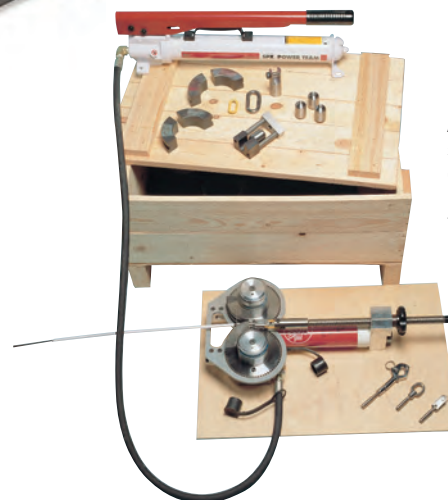

A200 shown with standard pulling devices and hand pump. (Johnson fittings not included).

# “NO WIRE” SPLICE LINE LIFE LINE FITTINGS



Johnson Marine’s Splice Line fittings allow you to easily splice hi tech Dyneema™ line to standard life line fittings. Our new Splice Line Fitting is available in Type 316 Stainless or hard-anodized 6061-T6 Aluminum. They are designed to be light weight and easy on the line. Both US Sailing and ISAF now allow Dyneema/Spectra life lines for offshore racing and Dyneema/Spectra is also a great product for the cruising sailor that wants to replace their stainless steel life line cables.

Johnson recommends and sells 1/4” (6mm) Dyneema™ line\* in grey and white. This line is a 12 strand single braid, 1/7th the weight of 1/4” 1x19 cable, offering the same strength at about the same cost. Johnson recommends changing out the line at 4 year intervals.

**PROFESSIONAL SPLICING RECOMMENDED - DYNEEMA LINE NOT INCLUDED.**

## Splice Line Kits

### Small Boat Kit – Cat. # SLK-30 (to 30’)

- Contents: 2 LS-3600
- 2 LS-2900
- 70’ Grey 1/4” (6mm) Dyneema™
- Splicing & Install Instructions
- Fid/Needle/Twine

### Large Boat Kit – Cat. # SLK-40 (to 40’)

- Contents: Same as SLK-30 only 90’ Dyneema™

*These kits include everything needed to install upper Dyneema™ life lines w/o gates. For double life lines, buy 2 kits. For adding a gate, use our gate kits:*

### Gate Kit – Midship (1 side) – Cat. # SLK-GKM

- Contents: 1 LS-3100, 1 LS-3200, 1 LS-3300, 1 LS-3400, 6’ Dyneema™

### Gate Kit – Aft (1 side) – Cat. # SLK-GKA

- Contents: 1 LS-3100, 1 LS-3300, 6’ Dyneema™



SPLICE  
SL  
LINES

## SPLICE LINE LIFE LINE FITTINGS

Dyneema Line not included with fittings.

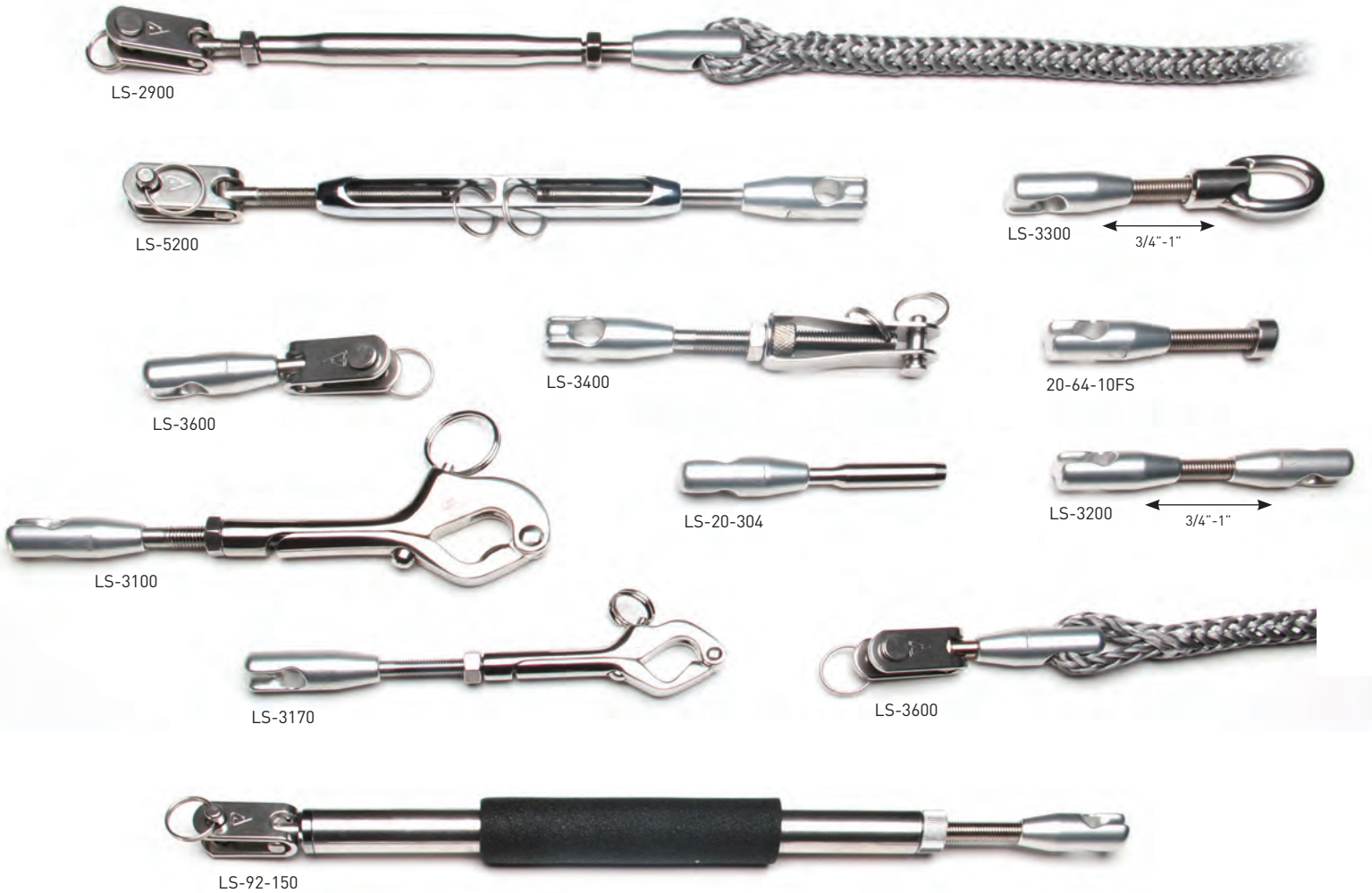

Cat. No.	Description
LS-2900	Tubular Turnbuckle w/ Splice Eye
LS-3100	Over Center Gate Hook w/ Splice Eye
LS-3170	Mini Gate Hook w/ Splice Eye
LS-3200*	Splice Eye to Splice Eye Fitting
LS-3300*	Gate Eye to Splice Eye Fitting
LS-3400	Adjuster w/ Splice Eye
LS-3600	Toggle Jaw w/ Splice Eye
LS-3650	Deck Terminal w/ Splice Eye
LS-20-304	Splice Eye to Swage End (1/8" wire)
LS-20-306	Splice Eye to Swage End (3/16" wire)

Cat. No.	Description
LS-5200	Open Body Turnbuckle w/ Splice Eye
LS-92-150	X-Tra Length Tubular Turnbuckle with Splice Eye
20-64-10FS*	Button to Splice Eye Fitting
BPG-2038	Stanchion Grommet. Drill size: 7/16" for 3/16" & 1/4" Dyneema
NE025-600	1 Spool of 600' 1/4" (6mm) Dyneema
NE025-600-50	50' Increments of 1/4" (6mm) Dyneema
<b>Splice Eye w/ Threaded Stud only: Includes cross-hole for cotter pin</b>	
20-61	1/4"-28 x 2-1/2" LH w/ Splice Eye
20-62	1/4"-28 x 2-1/2" RH w/ Splice Eye
20-63	5/16"-24 x 2-1/2" LH w/ Splice Eye
20-64	5/16"-24 x 2-1/2" RH w/ Splice Eye

\* Add -L for 1-1/4"



\* Add -L for 1-1/4"  
Dyneema line available in Grey or White.



BPG-2038

For Stainless fitting, add -316SS to Cat. No.

SPLICE  
SL  
LINES

*Not for lifting, hanging or other high load applications. See page 30 for Rigging Hardware.*

**D-I-Y HAND CRIMP LIFE LINE FITTINGS**

Hand Crimp Life Line Fittings were first developed by JOHNSON in 1967 after extensive testing. These fittings were designed for easy do-it-yourself installation by the boat owner or professional. Acceptance caught on quickly in the marine trade and became widely used by OEM's and boat owners alike. The 1969 LANDS' END hardware catalog even featured our fittings. Today our fittings are still widely used in the marine and now the architectural trade. A properly installed hand crimp fitting will hold \*65-70% of the breaking strength of 7x7 cable. The proper crimping tool and instructions must be used to assure a safe installation. Johnson sells two tools that can be used to crimp Johnson fittings (see page 29). Be sure to specify JOHNSON as these fittings have been copied around the world.

\* See note on page 29 regarding Hand Crimp terminal guidelines.



**TYPICAL SAILBOAT LIFE LINE SETUP**

HAND  
HC  
CRIMP

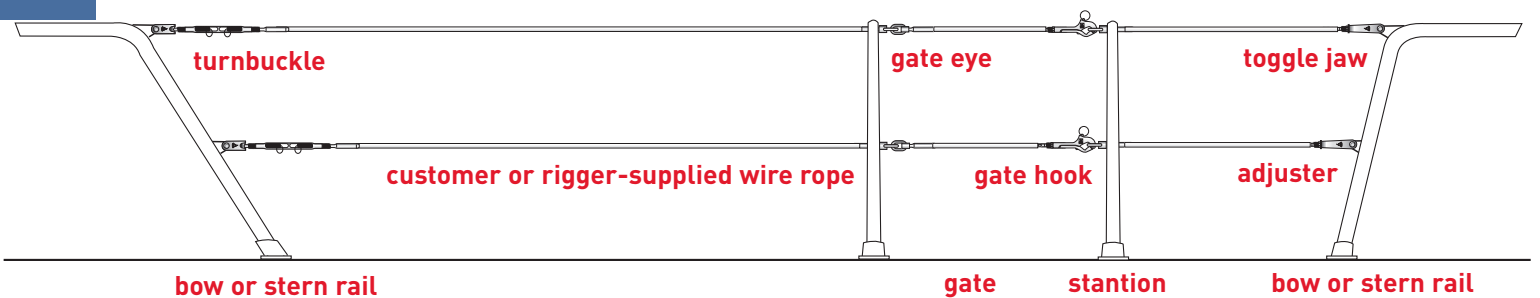

ALL TYPE 316 STAINLESS

## PELICAN HOOKS



### “OVER CENTER” SNAP GATE HOOK

This is our latest and best design yet. Features the “over center” design with no load on the swinging hook when closed. This feature allows easy opening yet stays secure with a heavy split ring on the plunger latching device. Investment Cast T-316 Stainless. Patent Numbers DES, 421.892 US 6,237,927 B1

26-884	1/8" wire	1/4"-28 L.H.	1-1/4" adj.
27-886	3/16" wire	5/16"-24 L.H.	1-1/4" adj.



### Snap Gate Hook - Body Only \*

For those that wish to replace their existing hooks - just match up the thread size. 31/2" long from end of body to inside bearing point of hook. Patent Numbers DES, 421.892 US 6,237,927 B1

21-80	5/16"-24 L.H.
21-80-1	5/16"-24 R.H.
21-81	1/4"-28 L.H.
21-88	8mm x 1.25 R.H.

\* Body Investment Cast in China

### Snap Gate Hook Repair Kit

21-850	Repair Kit for lost or worn latching mechanisms
R-4	Ring Only

### Mini Snap Gate Hook - “Over Center”

Our new Mini Snap Gate Hook features our same “Over-Center” design as our larger snap gate hook. This feature allows easy opening and closing with no load on the swinging hook when closed. Ideal for lower life lines and powerboats. 2-3/4" grip length, 3" overall. Investment Cast T-316 Stainless.

26-784	1/8" wire	1/4"-28 L.H.	1" adj.
27-786	3/16" wire	1/4"-28 L.H.	1" adj.
21-71	Body Only	1/4"-28 L.H.	1" adj.
21-750	Repair Kit for lost or worn latching mechanisms		

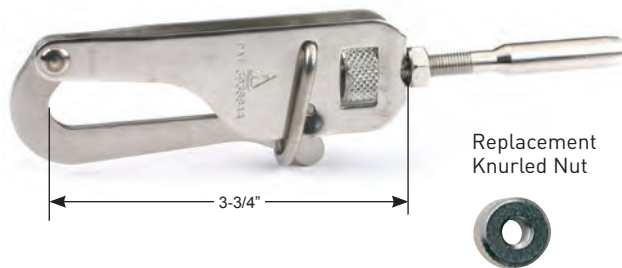

### Safe Lock Gate Hook T-316

Stainless, safe, inexpensive design *Practical Sailor* called a “well engineered hunk of metal”. Adjusts in place with knurled nut, stamped metal construction - 33/4" long from end of body to inside bearing point of hook.

26-404	1/8" wire	1/4"-28 L.H.	1-1/4" adj.
27-404	3/16" wire	1/4"-28 L.H.	1-1/4" adj.
35-622	Replacement Knurled Nut		

### Tubular Gate Hook T-316

Inexpensive, slender tubular design with a stamped hook. 43/4" long from end of body to inside bearing point of hook.

26-403	1/8" wire	1/4"-28 L.H.	1 1/2" adj.
27-403	3/16" wire	1/4"-28 L.H.	1 1/2" adj.

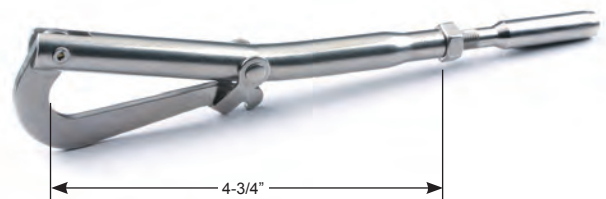

HAND  
HC  
CRIMP

BRONZE BODY / 316 STAINLESS ENDS

**OPEN BODY TURNBUCKLE**

Jaw to Swage

Classic, traditional design. Forged silicon bronze body with . . .T-316 stainless ends.

26-314	Chrome	1/8" wire 1/4" pin	3" adj.
27-316	Chrome	3/16" wire 1/4" pin	3" adj.



ALL TYPE 316 STAINLESS

**TUBULAR TURNBUCKLE**

Jaw to Swage - Check Nut Locking

Our most popular life line turnbuckle. Check nut locking.

26-412*	1/8" wire	1/4" pin	3" adj.
27-412*	3/16" wire	1/4" pin	3" adj.

\* Add "S" for Shortie Version



ALL TYPE 316 STAINLESS

**TUBULAR TURNBUCKLE**

Eye to Swage - Check Nut Locking

Used where an eye is required for attachment instead of a jaw-check nut locking.

26-401*	1/8" wire	3" adj.
27-401*	3/16" wire	3" adj.



HAND  
HC  
CRIMP

*Not for lifting, hanging or other high load applications. See page 30 for Rigging Hardware.*

### “Smooth Line” Turnbuckle

#### Closed Thread

Very popular architectural turnbuckle also great for life lines. No exposed threads. Cable termination is hidden inside of body and rotates on threaded cap. For details see page 5 of architectural section. T-316 stainless.

26-715	1/8" wire	1/4" pin	2" adj.
27-715	3/16" wire	1/4" pin	2" adj.

#### Smooth Line Replacement Parts

60-610	Nose Cone - 1/8"
60-611	Nose Cone - 3/16"
60-619+36-611	Crimp Sleeve - 1/8"
60-619	Crimp Sleeve - 3/16"

Crimp Sleeve 



### Adjuster Turnbuckle

#### Jaw to Hand Crimp Terminal

Stamped, strap design turnbuckle with knurled nut for adjustment. T-316 stainless/bronze construction.

26-302	1/8" wire	1/4" pin	2-3/4" adj.
27-302	3/16" wire	1/4" pin	2-3/4" adj.
35-624	Replacement Knurled Nut		

 35-624



### Deck Toggle Turnbuckle

#### Deck Toggle to Hand Crimp Terminal

This “T” bolt style fitting is used on decks or bulkheads. Toggle nut style also available to match old style. T-316 stainless.

26-412-1T*	1/8" wire	1/4"-28	3" adj.
27-412-1T*	3/16" wire	1/4"-28	3" adj.

\* Add “S” for Shortie Version



HAND  
HC  
CRIMP

Turnbuckle replacement parts on pages 26-28

#### Techno•TIP

Hand Crimp terminals, when properly applied, are approximately 65-70% of 7 x 7 wire strength. While this has proven adequate for life lines, we do not approve use of these fittings for standing rigging or other high load applications. Instructions for attachment (sent with order) must be followed.

ALL TYPE 316 STAINLESS

**Swivel, Single Gate Eye**

A single eye is used on one end of the gate area to attach the gate hook.



26-409 1/8" wire  
27-409 3/16" wire

**Threaded, Single Gate Eye**

Same as above only terminal is threaded into eye nut.



26-407 1/8" wire  
27-407 3/16" wire

**Swivel, Interlocking Gate Eye**

An interlocking gate eye is used at the opposite end of the gate hook as a "hinge" for the gate.



26-410 1/8" wire  
27-410 3/16" wire

**Threaded, Interlocking Gate Eye**

Same as above only terminal is threaded into eye nut.



26-408 1/8" wire  
27-408 3/16" wire

**Eye to Eye Fitting**

This fitting can be used wherever an eye is required on each side of the stanchion.

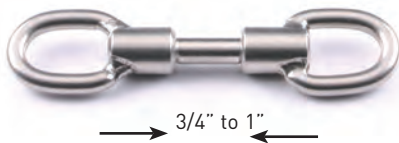

22-100 Adjustable between 3/4" and 1"

\* Add -L for 1-1/4"

**Eye to Interlocking Gate Eye Fitting**

This fitting can be used wherever an eye is required on one side, and an interlocking eye on the other side of a stanchion.



22-304-100 Adjustable between 3/4" and 1"

\* Add -L for 1-1/4"

HAND  
HC  
CRIMP

**Deck Toggle - Old Style**

This fitting can be used wherever a cable needs to be terminated to a deck or bulkhead.



26-405-1 1/8" wire "Old Style"  
27-405-1 3/16" wire "Old Style"

**Deck Toggle - 'T' Style**

Same Deck Toggle only "T" bolt construction.



26-415-1T 1/8" wire "T-Style"  
27-415-1T 3/16" wire "T-Style"



### Adjuster-Short

Generally used at the stern rail in conjunction with the single gate eye to tension that section of the gate.



26-406	1/8" wire 1/4" pin	1" adj.
35-620	Knurled Nut for 1/8" size	
27-406	3/16" wire 1/4" pin	1" adj.
35-621	Knurled Nut for 3/16" size	



### Toggle Jaw, "T" Style

Generally used at the stern rail when no gate is required with a turnbuckle forward.



26-415	1/8" wire 1/4" pin
27-415	3/16" wire 1/4" pin

### Toggle Jaw, Old Style

Same as above only uses toggle nut style instead of "T" bolt style.



26-405	1/8" wire 1/4" pin
27-405	3/16" wire 1/4" pin

### Eye to Jaw Fitting

This fitting will convert a small bail at the stern rail to our standard gate eye to accept our Over Center Gate Hook



Eye to Jaw	Cat. No. LS-2500
------------	------------------

### Eye to Deck Toggle Fitting

This fitting can be mounted to any flat surface and accept life line fittings, line, etc. Toggling action is 140 degrees.



Eye to Deck Toggle	Cat. No. LS-2550
--------------------	------------------

### Gate Eye to Stud with Button

These fittings can be used wherever a single or double gate eye is needed on one side of a stanchion.



22-304-10FS	Adjustable between 3/4" and 1"
22-303-10FS	Adjustable between 3/4" and 1"

HAND  
HC  
CRIMP

*Not for lifting, hanging or other high load applications. See page 30 for Rigging Hardware.*

ALL TYPE 316 STAINLESS

### Stanchion Eye

#### 1" Stanchion

This fitting is used on a stanchion for adding lower life lines without the need to drill holes for the cable to pass through. (5/16" hole).



Stanchion Eye Cat. No. 29-502

### Pulpit Anchor

#### 1" Rail

Can be used on the stern rail and bow pulpit to terminated jaw fittings for lower (or upper) life lines. (1/2" hole). Hole will not accept cast gate hooks.



Pulpit Anchor Cat. No. 29-501

### Diamond Pad Eye

#### 1/4" Bail

This pad eye can be used on deck for life lines or other applications. 750 lbs safe working load. See our hinged pad eyes on page 45.

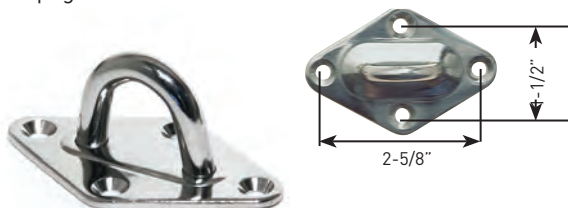

Diamond Pad Eye Cat. No. 28-501

### Gate Stop

These collars can be used at the gate instead of interlocking eyes, they maintain tension while the gate is open. A set-screw holds them in place.



29-507	1/8" max inside diameter
29-503	3/16" max inside diameter
29-503-1	5/32" max inside diameter
29-504	1/4" max inside diameter
29-505	5/16" max inside diameter
29-506	3/8" max inside diameter

### Stanchion Terminal

Used where the cable needs to be terminated at the stanchion.



26-405-5F	1/8" wire
27-405-5F	3/16" wire

### Double Hand Crimp Terminal Fitting

Used whenever two pieces of cable need to be joined.



27-415-5-6 1/8 to 3/16" Hand Crimp

### Conversion Sleeve - Nickel Brass

Allows the use of 3/16" life line fittings to be used with 1/8" cable. Slide over cable first then into fitting.



36-611 1/8 to 3/16" Hand Crimp

### Gate Eye No Stud - Type 316



\* Note - add -12 for RH

CAT. NO.	THREAD SIZE	DESCRIPTION
22-301-P	1/4-28 L.H.	Single Eye - 1/8" wire
22-303-P	5/16-24 L.H.	Single Eye - 3/16" wire
22-305-P	3/8-24 L.H.	Single Eye - 1/4" wire
22-302-P	1/4-28 L.H.	Intlkg Eye - 1/8" wire
22-304-P	5/16-24 L.H.	Intlkg Eye - 3/16" wire
22-306-P	3/8-24 L.H.	Intlkg Eye - 1/4" wire

### Knurled Nuts - Nickel Plated Bronze

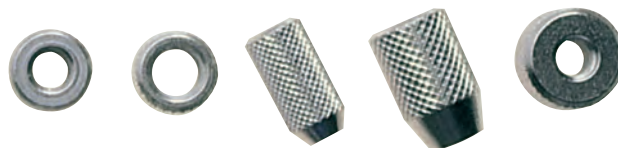

CAT. NO.	THREAD SIZE	DESCRIPTION	SERIES USED ON
35-620	1/4-28 L.H.	ADJUSTER	23-303, 406
35-621	5/16-24 L.H.	ADJUSTER	24-303, 27-406
35-622	1/4-28 L.H.	PELICAN HOOK	23/24-301, 26/27-404
35-623	10-32 R.H.	TURNBUCKLE	23-302/11 SER
35-624	1/4-28 R.H.	TURNBUCKLE	24-302/12 SER

### Turnbuckle Bodies T-316/Silicon Bronze

CAT. NO.	THREAD SIZE	OVERALL LENGTH	STYLE
34-601	10-32	3-1/2"	Tubular
34-602	1/4-28	4-1/2"	Tubular
34-602 S	1/4-28	3"	Tubular-Shortie
34-603	5/16-24	5-1/4"	Tubular
34-604	5/16-24	5-1/4"	Tubular-Slotted
34-605	3/8-24	5-1/2"	Tubular
34-606	3/8-24	5-1/2"	Tubular-Slotted
34-607	1/2-20	7"	Tubular-Slotted
34-608	5/8-18	8-1/2"	Tubular-Slotted

CAT. NO.	THREAD SIZE	OVERALL LENGTH	STYLE
34-609	1/4-28	4-1/2"	Tubular-Slotted
34-610	1/4-28	4-7/8"	Open Body
34-611	5/16-24	4-3/4"	Open Body
34-612	3/8-24	5-1/4"	Open Body
34-613	1/2-20	6-1/2"	Open Body
34-614	5/8-18	7-3/4"	Open Body
34-607-2	1/2-20	7"	Tubular
34-608-2	5/8-18	8-1/2"	Tubular



Use for Life Line or Rigging Applications.

### Turnbuckle/Deck Toggle Jaws T-316

CAT. NO.	THREAD SIZE	STYLE
33-601*	10-32 R.H.	T TOGGLE
33-602*	10-32 L.H.	T TOGGLE
33-615	1/4-28 R.H.	T TOGGLE
33-616	1/4-28 L.H.	T TOGGLE
33-605	1/4-28 R.H.	TOGGLE NUT
33-606	1/4-28 L.H.	TOGGLE NUT
33-607	5/16-24R.H.	TOGGLE NUT
33-608	5/16-24 L.H.	TOGGLE NUT
33-609	3/8-24 R.H.	TOGGLE NUT
33-610	3/8-24 L.H.	TOGGLE NUT
33-615-1	1/4-28 R.H.	DECK TOGGLE
33-616-1	1/4-28 L.H.	DECK TOGGLE
33-615S*	1/4-28 R.H.	SHORTIE
33-616S*	1/4-28 L.H.	SHORTIE

CAT. NO.	THREAD SIZE	STYLE
33-617	5/16-24R.H.	T TOGGLE
33-618	5/16-24 L.H.	T TOGGLE
33-617-1	5/16-24 R.H.	DECK TOGGLE
33-618-1	5/16-24 L.H.	DECK TOGGLE
33-619	3/8-24 R.H.	T TOGGLE
33-620	3/8-24 L.H.	T TOGGLE
33-611	1/2-20 R.H.	TOGGLE NUT
33-612	1/2-20 L.H.	TOGGLE NUT
33-613	5/8-18 R.H.	TOGGLE NUT
33-614	5/8-18 L.H.	TOGGLE NUT
33-603**	1/4-28 R.H.	BCKSTY ADJ.
33-604**	1/4-28 L.H.	BCKSTY ADJ.

\*\* For 01 Series Backstay Adjuster Only (Includes Square Nut)

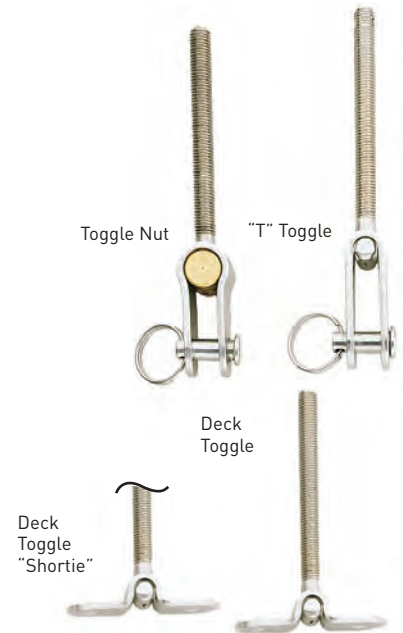

\* Also available in Deck Toggle Style.

All Toggle Jaws can be used for life line and rigging applications.  
Deck Toggles are used for Life line and Architectural applications only.

Use for Life Line or Rigging Applications.

### Locking Nuts



CAT. NO.	THREAD SIZE	CAT. # USED ON	CAT. NO.	THREAD SIZE	CAT. # USED ON
35-601	10-32 R.H.	03 & 11	35-608	3/8-24 L.H.	06 & 08
35-602	10-32 L.H.	03	35-609	1/2-20 R.H.	General
35-603	1/4-28 R.H.	04 & 19	35-610	1/2-20 L.H.	General
35-604	1/4-28 L.H.	04, 19 & 21	35-611	5/8-18 R.H.	General
35-605	5/16-24 R.H.	05 & 07	35-612	5/8-18 L.H.	General
35-606	5/16-24 L.H.	05 & 07			
35-607	3/8-24 R.H.	06 & 08			

See full strength nuts on page 33 ARCHITECTURAL side of the catalog.

ALL TYPE 316 STAINLESS

Not for lifting, hanging or other  
high load applications.  
See page 30 for Rigging Hardware.

## Threaded Life Line Terminals for Hand Crimp



CATALOG NUMBER	THREAD SIZE	WIRE SIZE	CAT # USED ON
31-601	1/4-28 L.H. x 3/8	1/8"	26-407 & 408
31-602***	1/4-28 L.H. x 1-1/2	1/8"	26-784, 26-406
31-603	1/4-28 L.H. x 2-1/2	1/8"	26-401, 26-884, 412 & 403
31-603-1	1/4-28 R.H. x 2-1/2	1/8"	GENERAL
31-603-1S	1/4-28 R.H. x 1-1/2	1/8"	Full Thread Terminal Tuners, "S" Series
31-603-1TT	1/4-28 R.H. x 3/8	1/8"	Blind Thread Terminal Tuners
31-604***	1/4-28 L.H. x 2-1/2	1/8"	26-404
31-605*	5/16-24 L.H. x 3/8	3/16"	27-407 & 408
31-606*	5/16-24 L.H. x 2	3/16"	27-406 & 26-413 & 27-413 & 27-886
31-606-1	5/16-24 R.H. x 2	3/16"	GENERAL
31-607*	1/4-28 L.H. x 2-1/2	3/16"	27-401 & 412 & 403
31-607-1*	1/4-28 R.H. x 2-1/2	3/16"	GENERAL
31-607S	1/4-28 L.H. x 1-1/2	3/16"	"S" Series, 27-786
31-607-1S	1/4-28 R.H. x 1-1/2	3/16"	Full Thread Terminal Tuners, "S" Series
31-607-1TT	1/4-28 R.H. x 3/8	3/16"	Blind Thread Terminal Tuners
*31-608***	1/4-28 L.H. x 2-1/2	3/16"	27-404
31-609	1/4-28 R.H. x 3-3/4	3/16"	27-302
26-405-5	1/4-28 R.H. x 3/8	1/8"	Special and 26-405-5F/B
27-405-5	1/4-28 R.H. x 3/8	3/16"	Special and 27-405-5F/B

\* - 3/16" terminals may be used for 1/8" wire - Order #36-611 sleeve

\*\*\* - Cross drilled for cotter pin.



photo courtesy of Zim Sailing

HAND  
HC  
CRIMP

## HAND CRIMP TOOLS

Johnson Hand Crimp Fittings have proven themselves over the years, however the overall integrity of the system depends on the proper tools for the job. We cannot stress enough the need to use either our #53-210 bolt tool or our #53-215 lever crimping tools built to handle the stress of crimping Johnson stainless fittings. "Micropress" tools were designed to crimp soft copper and aluminum oval and stop sleeves only. Johnson tools are designed with special width and relief patterns which apply to Johnson hand crimp fittings and instructions only. The use of other tools or crimping fittings other than Johnson hand crimp fittings with Johnson tools can result in failure of the terminal, personal injury or loss of life.

1. Our **Lever Type Tool** has two cavities for 1/8" and 3/16" Hand Crimp fittings. This is a good production tool for the dealer.

Lever Type Tool CAT. NO. 53-215

2. Our **Bolt Type Tool** should not be confused with other similar type tools. This tool works well for the boat owner replacing several or all life line fittings on their boat.

Bolt Type Tool CAT. NO. 53-210

3. Our **Felco Cable Cutter** will give you a clean, crisp cut through 1/4" sized cables. Swiss made.

Felco Cable Cutter CAT. NO. 53-220

4. Our **Larger Felco Cable Cutter** cuts cable through 3/8."

Felco Cable Cutter CAT. NO. 53-222

Our **Largest Felco Cable Cutter** cuts cable through 5/8".

Felco Cable Cutter CAT. NO. 53-224 (not shown)



### After Crimp Dimensions for Johnson Hand Crimp Fittings:

1/8" cable = .185  
3/16" cable = .265  
(+.000 -.003)

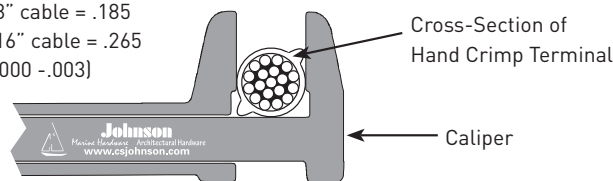

### Installation Instructions

Johnson Hand Crimp Life Line Terminals Using Hand Swaging Tool #53-215



#### TOOLS Required for Installation:

- Cable Cutter
- Marking pen or pencil
- Sharp knife
- Johnson Marine Life Line Tool [CAT. NO. 53-215]

Instructions apply to this tool only ... FAILURE could result from using other tools.

**IMPORTANT: Use only 1/8" or 3/16", preformed, corrosion resistant wire in 7x7 or 1x19 construction with finish dimensions to MIL-W-5424B**

- Adjust all turnbuckles & pelican hooks to 2/3 extended.
- Strip vinyl cover back to expose bare wire to dimensions shown in [A].
- \*\*\*Place terminal into proper die: 1/8" wire - Tool #53-215 die marked "1/8". 3/16" wire - Tool #53-215 die marked "3/16".
- Insert wire into terminal positioning approximately 1/8" from end. Make sure that vinyl cover is tight against terminal before crimping. Complete 3 crimps as shown in [B]. Use the gauge provided

with tool to check the after crimp dimension. Measure here...adjust tool if required.



- Attach completed terminal at required position and lead wire through stanchion eyes. Attach next terminal to be crimped at required position and while holding wire taut, mark wire as shown in [C].
- Repeat steps 2 thru 4.

\*Hand Crimp terminals when properly applied will withstand pullout strains of 65 to 70% of 7 x 7 wire strength. We do not warrant use of these terminals for standing rigging or other high load applications. \*\*1/8" wire may be used with 3/16 terminal by installing sleeve [CAT. NO. 36-611] into terminal.

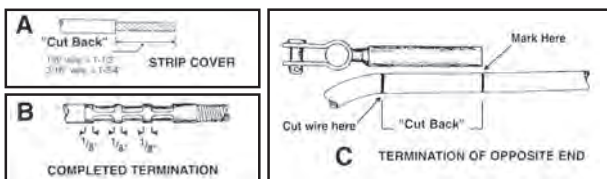

### Installation Instructions

Johnson Hand Crimp Using Hand Tool #53-210 Applies to use of 1/8" & 3/16" wire on #27 series (3/16") Terminals only (using adapter sleeve for 1/8" wire).



#### TOOLS Required for Installation:

- Cable Cutter
- Marking pen or pencil
- Sharp knife
- Johnson Marine Life Line Tool #10 [CAT. NO. 53-210]
- 1/2" Open End Wrench or Socket Wrench

Instructions apply to this tool only ... FAILURE could result from using other tools.

**IMPORTANT: Use only 1/8" or 3/16", preformed, corrosion resistant wire in 7x7 or 1x19 construction with finish dimensions to MIL-W-5424B**

- Adjust all turnbuckles and pelican hooks to 2/3 extended.
- Strip vinyl cover back 1 13/16" to expose bare wire.
- Insert terminal into die [marked 3/16"] as shown in [A]. Tighten clamping bolts just enough to grip terminal firmly.
- When using 1/8" wire, insert sleeve [CAT. NO. 36-611] into terminal. 3/16" wire does not require a sleeve.
- Insert wire into terminal, tighten clamping bolts alternately making sure the vinyl cover stays tight against terminal.
- Tighten bolts alternately until die blocks are fully closed and no space can be seen between them.

- Loosen bolts until terminal can be repositioned for next crimp.
- Position terminal as shown in [B] and repeat steps 6 & 7 until a total of five (5) crimps have been completed. Terminal should appear as shown in [C].
- Attach completed terminal at required position and lead wire through stanchion eyes. Attach next terminal to be crimped at required position and while holding wire taut, mark wire as shown in [D].
- Repeat steps 2 through 8.

\*Hand Crimp terminals when properly applied will withstand pullout strains of 65 to 70% of 7 x 7 wire strength. We do not warrant use of these terminals for standing rigging or other high load applications.

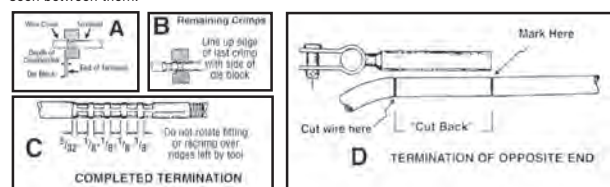

HAND HC CRIMP



# Johnson

Rigging Hardware



At Johnson Marine we understand what is needed to rig dinghies up through large cruisers. Johnson offers a full line of terminals, backstay/inner forestay turnbuckles, toggles, plates, pins and rings. Everything you need to rig and tune your boat safely.

- **Offshore-duty Rigging Turnbuckles**
- **Quick release levers, toggle jaws, adapter plates and shroud adjusters... regular and calibrated.**
- **Backstay Hardware**
- **Johnson Dependability... peace of mind while cruising.**
- **All terminals machined from T-316 stainless steel.**

### FIND THE RIGHT RIGGING HARDWARE FOR YOUR BOAT:





BRONZE BODY / 316 STAINLESS ENDS

MACHINE  
MS  
SWAGE

### Open Body Turnbuckles - Jaw and Jaw

For those who prefer a traditional body turnbuckle. The forged silicon bronze body, coupled with our integral toggle jaw, provides positive locking and ease of adjustment.

Forged silicon bronze bodies with 316 stainless ends offer a great non-galling combination. Integral toggle jaw eliminates the need for a separate rigging toggle.

REPLACEMENT PARTS ON PAGES 49-51

CAT. NO.	TYPE	WIRE SIZE	APPROX. BREAKING STRENGTH	SAFE WORKING LOAD	THREAD SIZE	PIN TO PIN LENGTH		BODY LENGTH	PIN DIA	WT. lb oz
						Closed	Open			
42-110**	Jaw/Jaw	To 5/32"	2,500 lbs	1000 lbs.	1/4-28	8"	11"	4-1/2"	1/4"	5
43-110**	Jaw/Jaw	To 3/16"	4,000 lbs.	1600 lbs	5/16-24	8-3/8"	12	4-7/8"	5/16"	8
44-110**	Jaw/Jaw	To 1/4"	7,000 lbs.	2800 lbs.	3/8-24	9-7/8"	13-7/8"	5-1/2"	3/8"	14
45-100	Jaw/Jaw	To 5/16"	10,500 lbs.	4200 lbs.	1/2-20	11-1/2"	15-1/2"	6-1/2"	1/2"	1 0
47-100	Jaw/Jaw	To 3/8"	14,800 lbs.	5900 lbs.	5/8-18	14-1/2"	19"	7-3/4"	5/8"	3 4

\*\* Jaw with "T" Toggle Construction. All others have bronze toggle nuts to prevent galling under high load conditions.



BRONZE BODY / 316 STAINLESS ENDS

MACHINE  
MS  
SWAGE

## Open Body Turnbuckles - Jaw and Machine Swage

REPLACEMENT PARTS ON PAGES 49-51

CAT. NO.	TYPE	WIRE SIZE	APPROX. BREAKING STRENGTH	SAFE WORKING LOAD	THREAD SIZE	ADJUSTMENT	BODY LENGTH	PIN DIA	WT. lb oz
42-113**	Jaw/Swage	3/32"	2,500 lbs	1000 lbs.	1/4-28	3"	4-1/2"	1/4"	4
42-114**	Jaw/Swage	1/8"	2,500 lbs	1000 lbs.	1/4-28	3"	4-1/2"	1/4"	4
42-115**	Jaw/Swage	5/32"	2,500 lbs	1000 lbs.	1/4-28	3"	4-1/2"	1/4"	4
43-115**	Jaw/Swage	5/32"	4,000 lbs.	1600 lbs	5/16-24	3-5/8"	4-7/8"	5/16"	7
43-116**	Jaw/Swage	3/16"	4,000 lbs.	1600 lbs	5/16-24	3-5/8"	4-7/8"	5/16"	7
44-116**	Jaw/Swage	3/16"	7,000 lbs	2800 lbs.	3/8-24	4"	5-1/2"	3/8"	12
44-117**	Jaw/Swage	7/32"	7,000 lbs	2800 lbs.	3/8-24	4"	5-1/2"	3/8"	12
44-118**	Jaw/Swage	1/4"	7,000 lbs	2800 lbs.	3/8-24	4"	5-1/2"	3/8"	12
45-108	Jaw/Swage	1/4"	10,500 lbs	3500 lbs.	1/2-20	4-1/8"	6-1/2"	1/2"	9
45-109	Jaw/Swage	9/32"	10,500 lbs	3500 lbs.	1/2-20	4-1/8"	6-1/2"	1/2"	9
45-110	Jaw/Swage	5/16"	10,500 lbs	4200 lbs.	1/2-20	4-1/8"	6-1/2"	1/2"	9
47-110	Jaw/Swage	5/16"	14,800 lbs	4200 lbs.	5/8-18	5"	7-3/4"	5/8"	3 8
47-112	Jaw/Swage	3/8"	14,800 lbs	5900 lbs.	5/8-18	5"	7-3/4"	5/8"	3 8

\*\* Jaw with "T" Toggle Construction. All others have bronze toggle nuts to prevent galling under high load conditions.



photo courtesy of Hake Yachts





ALL TYPE 316 STAINLESS

MACHINE  
MS  
SWAGE

**Stainless Steel Tubular Turnbuckles - Jaw and Jaw**  
Check Nut Locking

REPLACEMENT PARTS ON PAGES 49-51

CAT. NO.	TYPE	WIRE SIZE	APPROX. BREAKING STRENGTH	SAFE WORKING LOAD	THREAD SIZE	PIN TO PIN LENGTH		BODY LENGTH	PIN DIA	WT. lb oz
						Closed	Open			
03-110**	Jaw/Jaw	To 3/32"	1,000 lbs	400 lbs.	10-32	6-3/8"	8-7/8"	3-1/2"	3/16"	2.5
04-100	Jaw/Jaw	To 5/32"	2,500 lbs.	1000 lbs	1/4-28	8"	11"	4-1/2"	1/4"	5
04-110**	Jaw/Jaw	To 5/32"	2,500 lbs	1000 lbs.	1/4-28	8"	11"	4-1/2"	1/4"	5
04-110S**	Jaw/Jaw	To 5/32"	2,500 lbs	1000 lbs.	1/4-28	6-1/2"	9-1/2"	3"	1/4"	5
05-110**	Jaw/Jaw	To 3/16"	4,000 lbs.	1600 lbs.	5/16-24	9"	12-3/4"	5-1/8"	5/16"	8
06-110**	Jaw/Jaw	To 1/4"	7,000 lbs.	2800 lbs.	3/8-24	9-1/2"	13-3/4"	5-5/8"	3/8"	14
09-100-2	Jaw/Jaw	To 5/16"	10,500 lbs.	4200 lbs.	1/2-20	12"	16-3/4"	7"	1/2"	1 12
10-100-2	Jaw/Jaw	To 3/8"	14,800 lbs.	5900 lbs.	5/8-18	14"	19"	8-5/8"	5/8"	3 10

\*\*Jaw with "T" Toggle Construction. All others have bronze toggle nuts to prevent galling under high load conditions.

ALL TYPE 316 STAINLESS

MACHINE  
MS  
SWAGE

**Stainless Steel Tubular Turnbuckles - Classic Jaw & Machine Swage**  
Check Nut Locking

TECH TIP - Pin size = jaw width See page 48 for full specs of toggles

REPLACEMENT PARTS ON PAGES 49-51

CAT. NO.	TYPE	WIRE SIZE	APPROX. BREAKING STRENGTH	SAFE WORKING LOAD	THREAD SIZE	ADJUSTMENT	BODY LENGTH	PIN DIA	WT. lb oz
03-112*	Jaw/Swage	*1/16"	1,000 lbs	400 lbs.	10-32	2-1/2"	3-1/2	3/16"	2
03-113*	Jaw/Swage	3/32"	1,000 lbs	400 lbs.	10-32	2-1/2"	3-1/2	3/16"	2
04-103*	Jaw/Swage	3/32"	2,500 lbs	1000 lbs.	1/4-28	3"	4-1/2	1/4"	4
04-104	Jaw/Swage	1/8"	2,500 lbs	1000 lbs	1/4-28	3"	4-1/2	1/4"	4
04-105	Jaw/Swage	5/32"	2,500 lbs	1000 lbs	1/4-28	3"	4-1/2	1/4"	4
04-113**	Jaw/Swage	3/32"	2,500 lbs	1000 lbs.	1/4-28	3"	4-1/2	1/4"	4
04-114**	Jaw/Swage	1/8"	2,500 lbs	1000 lbs.	1/4-28	3"	4-1/2	1/4"	4
04-115**	Jaw/Swage	5/32"	2,500 lbs	1000 lbs.	1/4-28	3"	4-1/2	1/4"	4
05-115**	Jaw/Swage	5/32"	4,000 lbs	1600 lbs.	5/16-24	3-3/4"	5-1/8	5/16"	7
05-116**	Jaw/Swage	3/16"	4,000 lbs	1600 lbs.	5/16-24	3-3/4"	5-1/8	5/16"	7
06-116**	Jaw/Swage	3/16"	7,000 lbs	2800 lbs.	3/8-24	4-1/4"	5-5/8	3/8"	12
06-117**	Jaw/Swage	7/32"	7,000 lbs	2800 lbs.	3/8-24	4-1/4"	5-5/8	3/8"	12
06-118**	Jaw/Swage	1/4"	7,000 lbs	2800 lbs.	3/8-24	4-1/4"	5-5/8	3/8"	12
09-108-2	Jaw/Swage	1/4"	10,500 lbs	3500 lbs.	1/2-20	4-1/8"	7	1/2"	1 9
09-109-2	Jaw/Swage	9/32"	10,500 lbs	3500 lbs.	1/2-20	4-1/8"	7	1/2"	1 9
09-110-2	Jaw/Swage	5/16"	10,500 lbs	4200 lbs.	1/2-20	4-1/8"	7	1/2"	1 9
10-110-2	Jaw/Swage	5/16"	14,800 lbs	4200 lbs.	5/8-18	5"	8-5/8	5/8"	3 2
10-112-2	Jaw/Swage	3/8"	14,800 lbs	5900 lbs.	5/8-18	5"	8-5/8	5/8"	3 2

NOTE: The 03 & 04 series come standard with L.H. upper terminal. All other series have R. H. The 04 series is available with R. H. upper terminal. To order add -12 to the catalog number.  
 \*\*Jaw with "T" Toggle Construction. All others have bronze toggle nuts to prevent galling under high load conditions.  
 \*Swage with 3/32" die.



photo courtesy of Morris Yachts





ALL TYPE 316 STAINLESS

MACHINE  
MS  
SWAGE

**Positive Lock Stainless Steel Tubular Turnbuckles - Jaw and Jaw**

Positive locking with our LOCKING RINGS. They replace expendable cotter pins and being captive, can not be lost overboard. There are no pointed or rough ends to snag sails or shins.

REPLACEMENT PARTS ON PAGES 49-51

CAT. NO.	TYPE	WIRE SIZE	APPROX. BREAKING STRENGTH	SAFE WORKING LOAD	THREAD SIZE	PIN TO PIN LENGTH		BODY LENGTH	PIN DIA	WT. lb oz
						Closed	Open			
04-120**	Jaw/Jaw	To 5/32"	2,500 lbs.	1000 lbs.	1/4-28	7-3/4"	10-5/8"	4-1/2	1/4"	5
07-110**	Jaw/Jaw	To 3/16"	4,000 lbs.	1600 lbs.	5/16-24	8-1/2"	11-5/8"	5-1/8	5/16"	8
08-110**	Jaw/Jaw	To 1/4"	7,000 lbs.	2800 lbs.	3/8-24	9-1/4"	12-1/2"	5-5/8	3/8"	13
09-100	Jaw/Jaw	To 5/16"	10,500 lbs.	4200 lbs.	1/2-20	12"	16-3/4"	7	1/2"	1 12
10-100	Jaw/Jaw	To 3/8"	14,800 lbs.	5900 lbs.	5/8-18	14"	19"	8-5/8	5/8"	3 10

\*\*Jaw with "T" Toggle Construction. All others have bronze toggle nuts to prevent galling under high load conditions. See page 53 for replacement rings.

ALL TYPE 316 STAINLESS

MACHINE  
MS  
SWAGE

Positive Lock Stainless Steel Tubular Turnbuckles - Jaw & Machine Swage

REPLACEMENT PARTS ON PAGES 49-51

CAT. NO.	TYPE	WIRE SIZE	APPROX. BREAKING STRENGTH	SAFE WORKING LOAD	THREAD SIZE	ADJUSTMENT	BODY LENGTH	PIN DIA	WT. lb oz
04-123**	Jaw/Swage	3/32"	2,500 lbs	1000 lbs.	1/4-28	2-7/8"	4-1/2	1/4"	4
04-124**	Jaw/Swage	1/8"	2,500 lbs	1000 lbs.	1/4-28	2-7/8"	4-1/2	1/4"	4
04-125**	Jaw/Swage	5/32"	2,500 lbs	1000 lbs.	1/4-28	2-7/8"	4-1/2	1/4"	4
07-115**	Jaw/Swage	5/32"	4,000 lbs.	1600 lbs	5/16-24	3-1/8"	5-1/8	5/16"	1 7
07-116**	Jaw/Swage	3/16"	4,000 lbs.	1600 lbs	5/16-24	3-1/8"	5-1/8	5/16"	3 7
08-116**	Jaw/Swage	3/16"	7,000 lbs	2800 lbs.	3/8-24	3-1/4"	5-5/8	3/8"	11
08-117**	Jaw/Swage	7/32"	7,000 lbs	2800 lbs.	3/8-24	3-1/4"	5-5/8	3/8"	11
08-118**	Jaw/Swage	1/4"	7,000 lbs	2800 lbs.	3/8-24	3-1/4"	5-5/8	3/8"	11
09-108	Jaw/Swage	1/4"	10,500 lbs	3500 lbs.	1/2-20	4-1/8"	7	1/2"	1 9
09-109	Jaw/Swage	9/32"	10,500 lbs	3500 lbs.	1/2-20	4-1/8"	7	1/2"	1 9
09-110	Jaw/Swage	5/16"	10,500 lbs	4200 lbs.	1/2-20	4-1/8"	7	1/2"	1 9
10-110	Jaw/Swage	5/16"	14,800 lbs	4200 lbs.	5/8-18	5"	8-5/8	5/8"	3 2
10-112	Jaw/Swage	3/8"	14,800 lbs	5900 lbs.	5/8-18	5"	8-5/8	5/8"	3 2

NOTE: The 03 & 04 series come standard with L.H. upper terminal. All other series have R. H. The 04 series is available with R. H. upper terminal. To order add -12 to the catalog number.

\*\*Jaw with "T" Toggle Construction. All others have bronze toggle nuts to prevent galling under high load conditions.

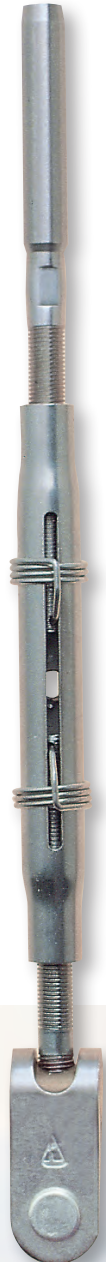



ALL TYPE 316 STAINLESS

**Handy Lock 46 Series for Backstays, Inner Forestays and Heavy Duty Tie Downs.**

The 46 Series is our largest **Handy Lock** turnbuckle. The 46 Series is constructed with a tubular body instead of an open body like the 01 and 02 Series. Two flip out handles provide tool free adjustment and positively lock the turnbuckle without cotter pins or check nuts. The **Handy Lock** has all the features needed for easy adjustment in a compact package. There are no sharp points to catch lines or tear sails, just flip the levers out to adjust and in to lock down. The 46 **Handy Lock** is available in Jaw & Jaw construction making it ideal for backstays. This 46 **Handy Lock** works great on an inner forestay vs. a larger more complicated Hyfield lever.

	CAT. NO.	TYPE	WIRE SIZE	APPROX. BREAKING STRENGTH	SAFE WORKING LOAD	THREAD SIZE	LENGTH		PIN DIA	WT.	
							Closed	Open		lb	oz
1	46-500	Jaw/Jaw	To 3/8"	14,800 lbs	5900 lbs.	5/8-18	15"	21"	5/8"	3	12
2	46-501	Jaw/Jaw	To 5/16"	10,500 lbs	4200 lbs.	5/8-18	15"	21"	1/2"	3	6
1	46-500-1	Jaw/Jaw	3/8"	14,800 lbs	5900 lbs.	5/8-18	15"	21"	5/8"	3	12
2	46-501-1	Jaw/Jaw	5/16"	10,500 lbs	4200 lbs.	5/8-18	15"	21"	1/2"	3	6
1	46-500-2	Jaw/Jaw	3/8"	14,800 lbs	5900 lbs.	5/8-18	15"	21"	5/8"	3	12
2	46-501-2	Jaw/Jaw	5/16"	10,500 lbs	4200 lbs.	5/8-18	15"	21"	1/2"	3	6

NOTE: Turnbuckles #1 and #2 may be fitted with a Quick Release Pin for use as a forestay release turnbuckle. -1 is for one pin. -2 is for two pins.

BILLET BRONZE BODY / 316 STAINLESS ENDS

### Handy Lock 01 Series for Shrouds and Stays Regular and Calibrated

The 01 Series **Handy Lock** turnbuckle is one of our oldest products and still stands the test of time. Neat and compact and positively locked without cotter pins or check nuts, the **Handy Lock** has all the features needed for easy adjustment in a compact package. There are no sharp points to catch lines or tear sails, just flip the lever up to adjust and down to lock. The 01 **Handy Lock** is available in Jaw & Jaw, Jaw & Swage and Calibrated construction. The calibrated version has a knurled knob incorporated into the upper stud end to provide tool free adjustment and a calibrated viewing slot to register your adjustment. Use the **Handy Lock** anywhere an easily adjusted turnbuckle is needed.

*Great for Tie Downs Too!*

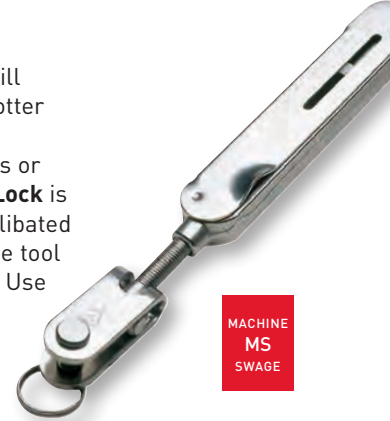
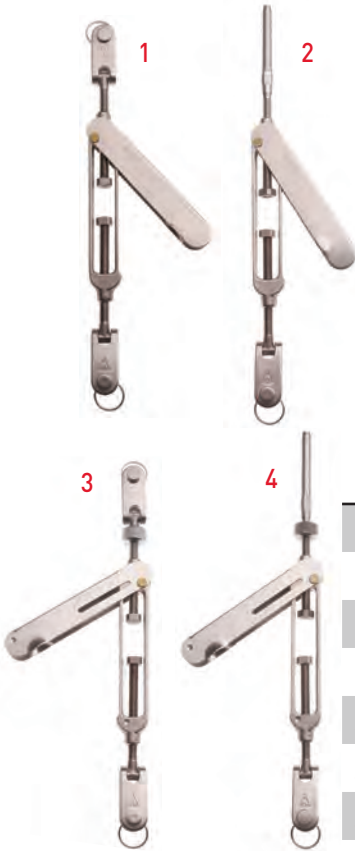

	CAT. NO.	TYPE	WIRE SIZE	APPROX. BREAKING STRENGTH	SAFE WORKING LOAD	THREAD SIZE	LENGTH		PIN DIA	WT. lb oz
							Closed	Open		
1	01-110	Jaw/Jaw	To 5/32"	2,500 lbs.	1000 lbs.	1/4-28	7-1/2"	10-1/2"	1/4"	7
2	01-113	Jaw/Swage	3/32"	2,500 lbs.	1000 lbs.	1/4-28	3" Adj.		1/4"	6
2	01-114	Jaw/Swage	1/8"	2,500 lbs.	1000 lbs.	1/4-28	3" Adj.		1/4"	6
2	01-115	Jaw/Swage	5/32"	2,500 lbs.	1000 lbs.	1/4-28	3" Adj.		1/4"	6
3	01-110-C	Jaw/Jaw	To 5/32"	2,500 lbs.	1000 lbs.	1/4-28	7-1/2"	10-1/2"	1/4"	7
4	01-113-C	Jaw/Swage	3/32"	2,500 lbs.	1000 lbs.	1/4-28	3" Adj.		1/4"	6
4	01-114-C	Jaw/Swage	1/8"	2,500 lbs.	1000 lbs.	1/4-28	3" Adj.		1/4"	6
4	01-115-C	Jaw/Swage	5/32"	2,500 lbs.	1000 lbs.	1/4-28	3" Adj.		1/4"	6

BILLET BRONZE BODY / 316 STAINLESS ENDS

### Handy Lock 02 Series for Shrouds, Stays and Tie Downs

The 02 Series **Handy Lock** turnbuckle is the big brother to the 01 Series. Two flip out handles provide tool free adjustment and positively lock the turnbuckle without cotter pins or check nuts. The **Handy Lock** has all the features needed for easy adjustment in a compact package. There are no sharp points to catch lines or tear sails, just flip the levers out to adjust and in to lock down. The 02 **Handy Lock** is available in Jaw & Jaw and Jaw & Swage construction making it ideal for backstays or inner forestays. Use the **Handy Lock** anywhere an easily adjusted turnbuckle is needed.

	CAT. NO.	TYPE	WIRE SIZE	APPROX. BREAKING STRENGTH	SAFE WORKING LOAD	THREAD SIZE	LENGTH		PIN DIA	WT. lb oz
							Closed	Open		
1	02-100	Jaw/Jaw	To 1/4"	7,000 lbs.	2,800 lbs.	3/8-24	13-1/4"	19-1/4"	3/8"	1 13
2	02-106	Jaw/Swage	3/16"	7,000 lbs.	2,800 lbs.	3/8-24	6" Adj.		3/8"	1 10
2	02-107	Jaw/Swage	7/32"	7,000 lbs.	2,800 lbs.	3/8-24	6" Adj.		3/8"	1 10
2	02-108	Jaw/Swage	1/4"	7,000 lbs.	2,800 lbs.	3/8-24	6" Adj.		3/8"	1 10
2	02-106-1	Jaw/Swage	3/16"	7,000 lbs.	2,800 lbs.	3/8-24	6" Adj.		3/8"	1 10
2	02-107-1	Jaw/Swage	7/32"	7,000 lbs.	2,800 lbs.	3/8-24	6" Adj.		3/8"	1 10
2	02-108-1	Jaw/Swage	1/4"	7,000 lbs.	2,800 lbs.	3/8-24	6" Adj.		3/8"	1 10



NOTE: Turnbuckles #1 and #2 may be fitted with a Quick Release Pin for use as a forestay release turnbuckle. -1 is for one pin. Sustainute -2 for two pins

## SMALL BOAT STAY AND SHROUD ADJUSTERS



photo courtesy of Zim Sailing



12-104-CCA-P  
(Harken  
Cam Cleat  
not included)

ALL TYPE 316 STAINLESS

### Shroud Adjuster - Calibrated

Here is an extremely functional stainless steel fitting. Adjustment is made by turning the knurled nut. The terminal rod is made captive, therefore it cannot turn and cannot come apart even when fully extended. It produces a "fool proof" adjuster which cannot come apart either by an inexperienced crew or during the vibration of trailering on the road.

Our popular 12 series stay adjuster is now available with a welded plate to accept a Harken 468 micro cam cleat (or similar with 1- 1/16" (27mm) hole spacing). Available in port and starboard configurations.

Use: Part # + CCA-P (or -S) example: 12-104-CCA-P.

CAT. NO.	TYPE	WIRE SIZE	APPROX. BREAKING STRENGTH	THREAD SIZE	LENGTH		PIN DIA	SWL
					Closed	Open		
11-100	Jaw/Eye	1/16", 3/32"	1,000 lbs	10-32	5"	7"	3/16"	400 lbs
11-102	Jaw/Swage	*1/16"	1,000 lbs.	10-32	2" adj.		3/16"	400 lbs
11-103	Jaw/Swage	3/32"	1,000 lbs.	10-32	2" adj.		3/16"	400 lbs
12-100	Jaw/Eye	To 5/32"	3,000 lbs.	1/4-28	5 5/8"	8 3/8"	1/4"	1000 lbs
12-104	Jaw/Swage	1/8"	3,000 lbs.	1/4-28	2 3/4" adj.		1/4"	1000 lbs
12-105	Jaw/Swage	5/32"	3,000 lbs.	1/4-28	2 3/4" adj.		1/4"	1000 lbs

\*Swage with 3/32" die.

**Replacement Knurled Nuts:** Order Cat#35-623 for 10-32 thread, Cat#35-624 for 1/4-28 thread.



ALL TYPE 316 STAINLESS



### Shroud Adjuster - Quick Release

Developed for dry sailed one-design dinghies. When the Quick Release pin is pulled, easy adjustment and unrigging can be obtained.

*NOTE: Quick Release Pins available - see chart page 53.*

CAT. NO.	WIRE TERMINAL PIN	CHAIN PLATE PIN	MAX. WIRE SIZE	PIN TO PIN ADJUSTMENT	SAFE WORKING LOAD
15-212	3/16"	1/4"	1/8"	1 3/4" to 3 5/8"	400 lbs.

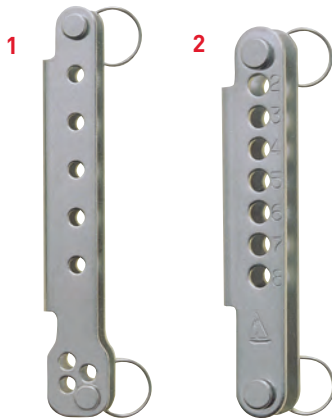

### Shroud Adjusters - Single Row Hole

These single row hole adjusters are good for applications where precise tuning is not required.

	CAT. NO.	TOTAL ADJ.	INCREMENT	PIN DIAMETER	JAW WIDTH	SWL
1	15-203	3-1/4"	9/64"	3/16"	3/8"	400 lbs
2	15-205*	2 5/8"	3/8"	1/4"	5/16"	1000 lbs

\*Calibrated



### Shroud Adjusters - Double Row Hole

These double row hole adjusters offer more precise tuning for stays and shrouds.

	CAT. NO.	TOTAL ADJ.	INCREMENT	PIN DIAMETER		JAW WIDTH	SWL
				UPPER	LOWER		
3	15-204-1*	2 1/2"	5/32"	3/16"	1/4"	3/8"	400 lbs
4	15-204	2 1/2"	5/32"	3/16"	3/16"	3/8"	400 lbs

\*Calibrated

photo courtesy of Zim Sailing



ALL TYPE 316 STAINLESS

**Quick Release Levers**

The Johnson Hyfield Type Lever has a number of very practical features that have been developed after extensive testing on both high performance multi-hulls and monohulls. The fitting is rugged, having an ultimate strength of 2500 lbs. A positive stop is provided to prevent jamming fingers between fitting and wire when thrown open under load and the large surface area of the push pad makes it easier to close lever under load. Lever take-up is 2 1/8" to an over-center position and comes with a quick release pin for positive locking. The extender arm may be had in either 1/4" or 5/16" pin size.

This is an essential piece of hardware on Catamaran shrouds to allow the crew to right the boat after a capsize, without it, another boat or extraordinary effort is required.

Trailable boats up to 26 feet find that a lever on the forestay greatly facilitates stepping and unstepping the mast.

NOTE: Quick Release Pins available - see chart page 53.



CAT. NO.	EXTENDER # OF HOLES	WIRE SIZE	APPROX. BREAKING STRENGTH	PIN DIA	Q.R. THROW	PIN TO PIN	SWL
14-205	3	To 1/8"	2,500 lbs.	1/4"	2-1/4"	7-3/8" min. — 8-3/8" max. in 1/2" increments	1000 lbs
14-206	4	To 5/32"	2,500 lbs.	Ext. 5/16" Chainplate 1/4"	2-1/4"	6-7/8" min. — 8-3/8" max. in 1/2" increments	1000 lbs

ALL TYPE 316 STAINLESS

**Large Quick Release Levers**

This new quick release lever is similar in principle to our popular 14-205/206 series. It is larger with an ultimate strength of 4000 lbs. It is supplied with either an extender for a terminal eye or a 5/32" or 3/16" wire swage terminal. Comes complete with a quick release pin for instant throw off. It features an over center lever intended for headstays on trailerable boats. Can also be used for inner forestays on larger boats in the 30 ft. range.

NOTE: Quick Release Pins available - see chart page 53.

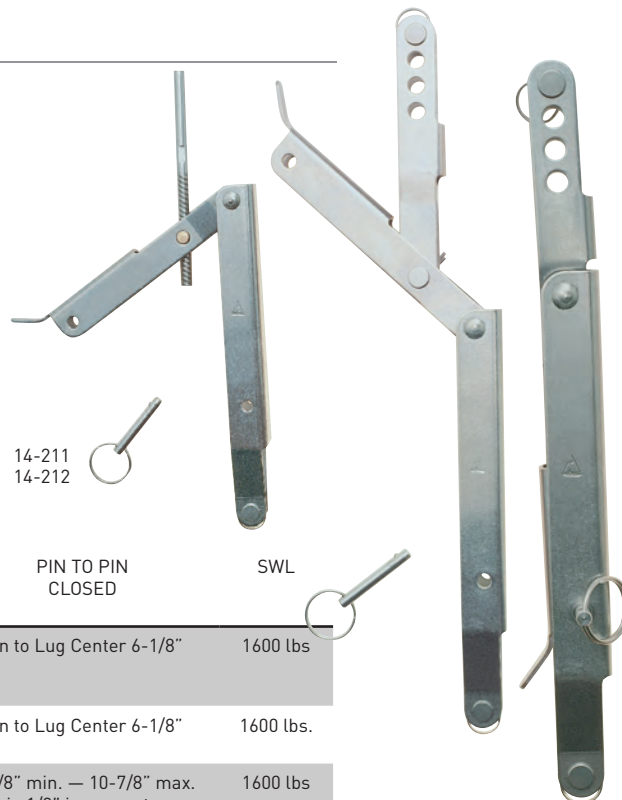

CAT. NO.	TYPE	WIRE SIZE	APPROX. BREAKING STRENGTH	PIN DIA	MAX ADJ.	Q.R. THROW	PIN TO PIN CLOSED	SWL
14-200*	1/4-28 R.H. Lug only	1/8", 5/32"	4,000 lbs.	5/16"	2-1/4"	2-5/8"	Pin to Lug Center 6-1/8"	1600 lbs
14-211-5*	5/16-24 R.H. Lug only	3/16"	4,000 lbs.	5/16"	2-1/4"	2-5/8"	Pin to Lug Center 6-1/8"	1600 lbs.
14-210	Extender	5/32", 3/16"	4,000 lbs.	5/16"	—	2-5/8"	9-3/8" min. — 10-7/8" max. in 1/2" increments	1600 lbs
14-211	Swage Term.	5/32"	4,000 lbs.	5/16"	2-1/4"	2-5/8"	Pin to Lug Center 6-1/8"	1600 lbs
14-212	Swage Term.	3/16"	4,000 lbs.	5/16"	2-1/4"	2-5/8"	Pin to Lug Center 6-1/8"	1600 lbs

\* No Terminal

MACHINE  
MS  
SWAGE

ALL TYPE 316 STAINLESS

### Inner Forestay Lever

After much feedback from our customers, Johnson has brought back a re-designed Inner Forestay Release Lever. The “over center” lever features a new non-fouling locking device. This new lever features: Modular, welded T-316 materials for strength. Two sizes to cover 1/4” thru 3/8” wire sizes. Curved release/takeup handle for safety. The female threaded lug at the top accepts swaged ends, toggle jaws or mechanical fittings and allows for 2-1/4” of adjustment.

Overall length with handle 20” - Quick Release Throw 3”.

Cat #	Pin Size	Wire Size	Breaking Strength	SWL	Length Closed	Length Open	Thread Size	Approx. Weight
54-800	1/2”	Lug Only	10,750	4300	11”	14”	1/2-20	3.5 lbs
54-810	1/2”	1/4”	10,750	4300	11”	14”	1/2-20	4 lbs
54-820	1/2”	9/32”	10,750	4300	11”	14”	1/2-20	4 lbs
54-850	5/8”	Lug Only	14,500	5800	11”	14”	5/8-18	3.5 lbs
54-860	5/8”	5/16”	14,500	5800	11”	14”	5/8-18	4.5 lbs
54-870	5/8”	3/8”	14,500	5800	11”	14”	5/8-18	4.5 lbs

Length open = Top of threaded lug to lower pin center, open position  
Length closed = Same as above only closed position

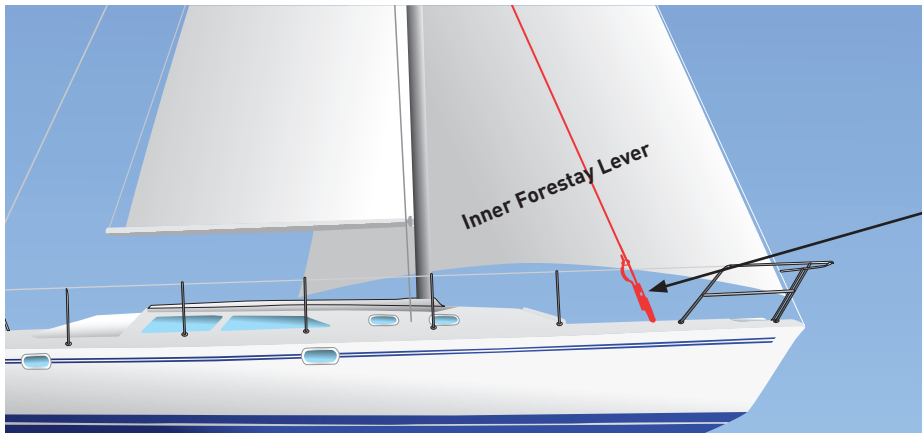

Use: 12-123 (1/2”) or 12-124 (5/8”) and use the Quick Release Pin supplied with your unit.



Optional Rigging Toggle



Redesigned Positive Locking Closure with Quick Pin



ALL TYPE 316 STAINLESS

### Inner Forestay Storage Bridle

An improvement from our earlier design. Features an overall 12" length, welded 316 stainless plate design with center bracket to attach your tackle to. The end brackets, together with the stainless plates, keep your inner forestay secure while stowed. Center bracket eyelet measures 3/8". For use with up to 1/2" inner forestays.



Inner Forestay Storage Bridle      Cat. No. 49-250

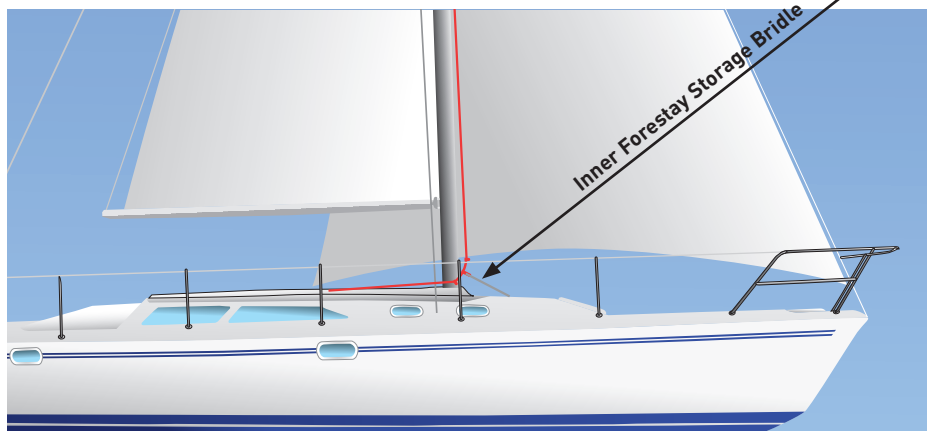

316 STAINLESS BILLET

### Stainless Jack Line Fairlead

Finally, a central Jack Line mount to get your Jack Lines off the deck, the preferred way to install allowing for a shorter tether and shorter fall. Mount this new billet 316 stainless fairlead to a shroud 5 or 6 feet above the deck. Run a 3/8" diameter low stretch line from a stern cleat through the fairlead (1/2" dia.) then to a bow cleat. You are then ready to clip your safety harness to the Jack Line.

Fits wire, rod or Dyform shrouds from 5/16" to 1/2". Rugged, CNC machined from billet 316 stainless. 4 1/4"-20 cap screws securely mount the fairlead to your shroud. Designed to be snug without over-clamping or damaging your rigging. Complete kit includes wedge and shims for 5/16" - 1/2" sizes. Smooth back side helps prevent sail handling hang-ups. Measures: 2 3/8" L, 1 5/16" W, 2 1/2" D.

Stainless Jack Line Fairlead      Cat. No. 49-100 (WEB STORE ONLY)

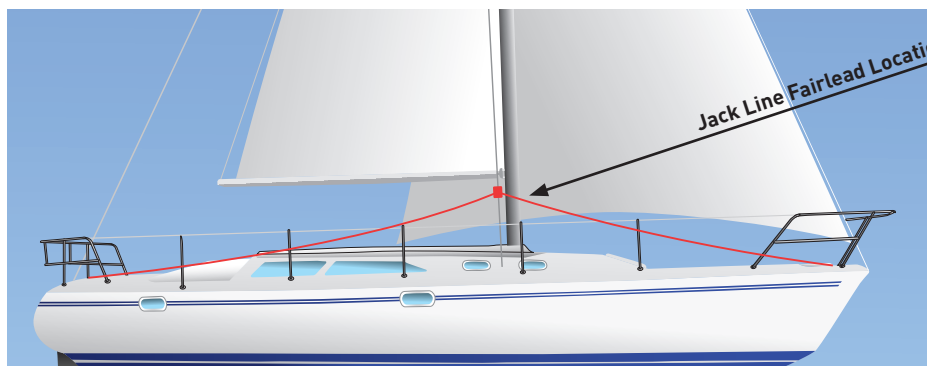

ALL TYPE 316 STAINLESS

### Split Backstay Cars

This adjusting car replaces separate blocks and a connecting member. Tandem sheaves eliminate severe flexing of the backstay, providing a neat, thoroughly functional fitting. The 38 Series with Delrin sheaves is intended for boats under 30ft., while the husky 39 Series with aluminum sheaves is intended for boats up to 40 feet.

Note: For maximum car release, use a 1.5 to 1 ratio between backstay base width and car height. Example: If backstay width is 5'-car height should not exceed 7 1/2' to 8' in height off deck. Higher ratios may require manual release with aid of boat hook, etc.

CAT. NO.	FIG. NO.	MAX. WIRE DIA.	DOWNHAUL FITTING
38-201	3	3/16"	SHEAVE ONLY
38-202	1	3/16"	BECKET ONLY
38-203	2	3/16"	SHEAVE & BECKET
39-201	3	1/4"	SHEAVE ONLY
39-202	1	1/4"	BECKET ONLY
39-203	2	1/4"	SHEAVE & BECKET
38-213	38 Series	3/16"	(4) RPL. DELRIN SHEAVES
39-213	39 Series	1/4"	(1) ALUMINUM SHEAVE
X7000	XTreme	3/8"	SHEAVE ONLY



XTreme Duty



Sheave & Becket



Becket Only



Sheave Only



Replacement Sheaves

### EXAMPLE

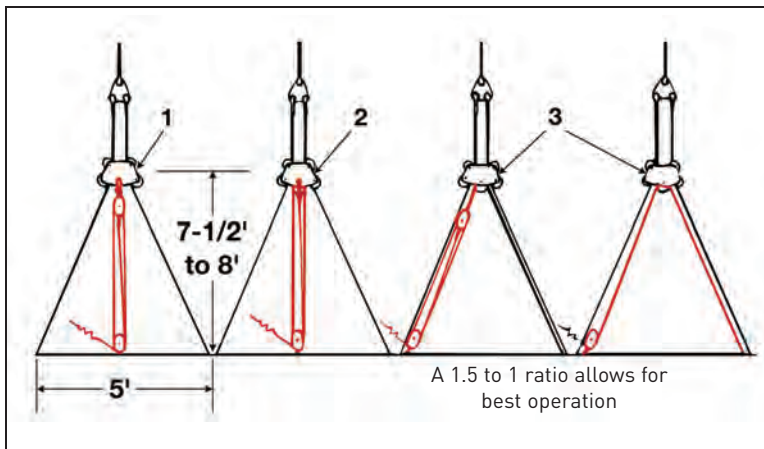

Patent Number 4224890

ALL TYPE 316 STAINLESS

### Stay Extenders / Link Plates

These stainless steel plates are designed for extending short stays, or to replace a turnbuckle. Several of these are a must for the ship's kit. All sizes include pins.

CAT. NO.	PIN DIA.	MAX. PIN TO PIN	SAFE WORKING LOAD
16-204	1/4"	3 3/4"	1000 lbs.
16-205	5/16"	4 3/8"	1600 lbs.
16-206	3/8"	5"	2800 lbs.
16-208	1/2"	5-5/8"	4200 lbs.
16-210	5/8"	6-7/8"	5900 lbs.
16-212	3/4"	9"	9000 lbs.



### Jaw/Eye Adapter Link Plates

These very useful links come in pairs and will allow you to convert an eye to a jaw or a jaw to an eye.

\* Dash numbers have one hole bushed to accommodate dissimilar pin sizes. Must be used in pairs. Pins not included.

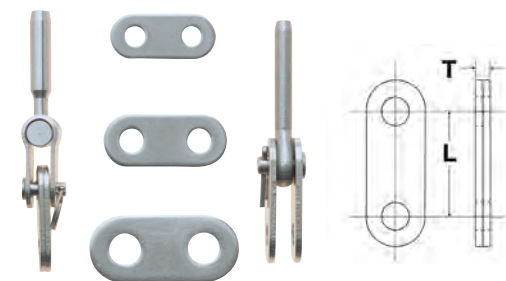

CAT. NO.	PIN DIA.	L	T	SAFE WORKING LOAD
52-124	5/16"	1-5/16"	.185	1600 lbs.
52-125	3/8"	1-1/8"	.250	2800 lbs.
52-126	1/2"	1-5/16"	.280	4200 lbs.
52-127	5/8"	1-5/8"	.370	5900 lbs.
52-128	3/4"	2"	.525	9000 lbs.
52-126-1*	3/8 to 1/2"	1-5/16"	.280	2800 lbs.
52-127-1*	1/2 to 5/8"	1-5/8"	.370	3500 lbs.

### Backstay Diamond Plates

#### Diamond Plate - Backstay

An integral part of the Johnson Marine Split Backstay Adjuster System. Part No. 38-211 & 212 are double plates and may also be used with eye terminals.

Pins not included.

CAT. NO.	PIN DIA.	SAFE WORKING LOAD
38-210	1/4"	1000 lbs.
38-211	5/16"	1600 lbs.
38-212	3/8"	2800 lbs.

#### Large Diamond Plates

This design compliments the looks of our new larger backstay car. Comes complete with cotter and clevis pins. T-316 stainless steel. Must be used in pairs.

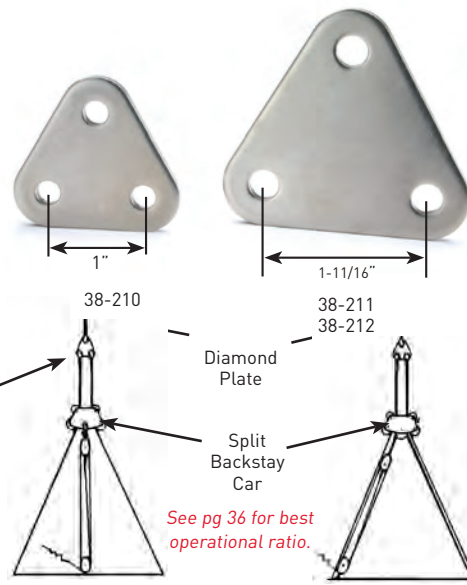

Vertical Tackle Example

Open Transom Example

See pg 36 for best operational ratio.

CAT. NO.	PIN SIZE TOP HOLE	PIN SIZE BOTTOM HOLE	PLATE THICKNESS	PIN TO PIN L BOTTOM	PIN TO PIN L BOTTOM TO TOP	SAFE WORKING LOAD
X7050	1/2"	1/2"	3/16"	2"	2-1/4"	4200 lbs.
X7051	5/8"	5/8"	3/16"	2-1/4"	2-1/2"	5900 lbs.
X7052	3/4"	5/8"	1/4"	2-1/4"	2-3/4"	9000 lbs.

**ALL TYPE 316 STAINLESS**

**Marine Eyes & Fork**

These new marine and MS style eyes and forks are manufactured by Johnson in the USA on the latest CNC machinery. All fittings are T-316 stainless steel with the quality you expect from Johnson.

**Marine Eyes - Machine Swage T-316**

CAT. NO.	WIRE SIZE	PIN SIZE	THICKNESS	SAFE WORKING LOAD
12-201	3/32"	1/4"	7/32"	400 lbs.
12-202	1/8"	1/4"	7/32"	700 lbs.
12-203	5/32"	5/16"	9/32"	1100 lbs.
12-204	3/16"	3/8"	11/32"	1600 lbs.
12-205	7/32"	7/16"	13/32"	2100 lbs.
12-206	1/4"	1/2"	15/32"	2800 lbs.
12-207	9/32"	1/2"	15/32"	3500 lbs.
12-208	5/16"	5/8"	19/32"	4200 lbs.
12-209	3/8"	5/8"	19/32"	5900 lbs.
12-210	7/16"	3/4"	23/32"	8000 lbs.



Pins Not Included  
see pages 51

**MACHINE  
MS  
SWAGE**

**MS Style Eyes - Machine Swage T-316**

CAT. NO.	WIRE SIZE	PIN SIZE	THICKNESS	SAFE WORKING LOAD
12-211	3/32"	3/16"	1/8"	400 lbs.
12-212	1/8"	3/16"	3/16"	700 lbs.
12-213	5/32"	1/4"	3/16"	1100 lbs.
12-214	3/16"	5/16"	1/4"	1600 lbs.
12-215	7/32"	5/16"	9/32"	2100 lbs.
12-216	1/4"	3/8"	5/16"	2800 lbs.
12-217	9/32"	7/16"	5/16"	3500 lbs.
12-218	5/16"	7/16"	11/32"	4200 lbs.
12-219	3/8"	1/2"	3/8"	5900 lbs.



Pins Not Included  
see pages 51

**MACHINE  
MS  
SWAGE**

**MS Style Fork - Machine Swage T-316**

CAT. NO.	WIRE SIZE	CLEVIS PIN REQUIRED	OPENING	DEPTH FROM PIN CENTER	SAFE WORKING LOAD
12-221	3/32"	CP-3-9	7/64"	11/16"	400 lbs.
12-222	1/8"	CP-3-13	3/16"	3/4"	700 lbs.
12-223	5/32"	CP-4-13	13/64"	13/16"	1100 lbs.
12-224	3/16"	CP-5-18	17/64"	7/8"	1600 lbs.
12-225	7/32"	CP-5-22	19/64"	1"	2100 lbs.
12-226	1/4"	CP-6-26	5/16"	1-5/64"	2800 lbs.
12-227	9/32"	CP-7-28	21/64"	1-11/64"	3500 lbs.
12-228	5/16"	CP-7-28	23/64"	1-17/64"	4200 lbs.
12-229	3/8"	CP-8-28	3/8"	1-35/64"	5900 lbs.



Pins Not Included  
see pages 51

**Call for OEM and  
Bulk Pricing!**

ALL TYPE 316 STAINLESS

MACHINE  
MS  
SWAGE

### Toggle Jaws for Machine Swage

This fitting's universal toggle action prevents any adverse bending of wire. Pins included.



Toggle Nut Style



"T" Toggle Style

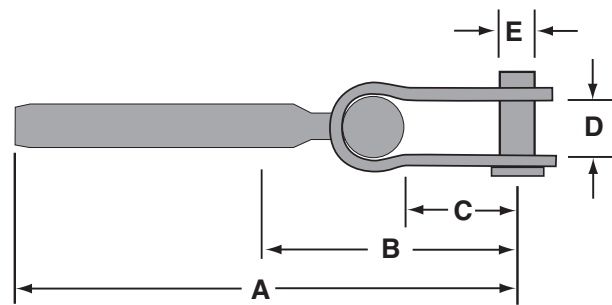

CAT. NO.	WIRE SIZE	A	B	C	D	E	F	BEFORE SWAGE DIA. *	AFTER SWAGE DIA. *	SAFE WORKING LOAD
17-203	3/32"	2-3/4"	1-1/2"	11/16"	1/4"	1/4"		.218	.190	1000 lbs
17-204	1/8"	3"	1-1/2"	11/16"	1/4"	1/4"	5/8"	.250	.219	1000 lbs
17-214**	1/8"	2-7/8"	1-5/16"	3/4"	1/4"	1/4"		.250	.219	1000 lbs
17-205	5/32"	3-1/4"	1-1/2"	11/16"	1/4"	1/4"		.297	.250	1000 lbs
17-205-2	5/32"	3-3/4"	2-1/8"	1"	5/16"	5/16"	3/4"	.297	.250	1600 lbs
17-215-2**	5/32"	4-1/2"	2-5/8"	1"	5/16"	5/16"		.297	.250	1600 lbs
17-206	3/16"	4-1/4"	2-1/4"	7/8"	3/8"	3/8"		.359	.313	1600 lbs
17-216**	3/16"	4-3/4"	2-5/8"	1"	5/16"	5/16"	7/8"	.359	.313	1600 lbs
17-207	7/32"	4-1/2"	2-1/4"	7/8"	3/8"	3/8"		.427	.375	2800 lbs
17-208	1/4"	4-3/4"	2-1/4"	7/8"	3/8"	3/8"		.494	.438	2800 lbs
17-209	1/4"	5-1/4"	2-5/8"	1-1/16"	1/2"	1/2"		.494	.438	2800 lbs
17-210	9/32"	5-1/2"	2-7/8"	1-1/16"	1/2"	1/2"	1-1/8"	.563	.500	3500 lbs
17-211	5/16"	5-3/4"	2-7/8"	1-1/16"	1/2"	1/2"		.635	.563	4200 lbs
17-212	5/16"	6-1/2"	3-1/4"	1-3/16"	5/8"	5/8"		.635	.563	4200 lbs
17-213	3/8"	7"	3-1/4"	1-5/16"	5/8"	5/8"	1-3/8"	.703	.625	5900 lbs

\*\* With T-Toggle Jaw

\*All tolerances are: +.000 - .005 Dimensions shown are inches.

NOTE: Before and After swage dimensions are mil spec and conform to both our life line and rigging fittings with regard to all aspects except cable depth in fittings. (See chart on page 12 ARCHITECTURAL side of the catalog.) The primary difference between life line and rigging fittings is the cable depth, although other factors exist. Always use rigging fittings when in doubt or wherever high load applications exist. Never exceed the safe working load.



**ALL TYPE 316 STAINLESS**

**Turnbuckle Bodies T-316/Silicon Bronze**

CAT. NO.	THREAD SIZE	OVERALL LENGTH	STYLE	CAT. NO.	THREAD SIZE	OVERALL LENGTH	STYLE
34-601	10-32	3-1/2"	Tubular	34-609	1/4-28	4-1/2"	Tubular-Slotted
34-602	1/4-28	4-1/2"	Tubular	34-610	1/4-28	4-7/8"	Open Body
34-602 S	1/4-28	3"	Tubular-Shortie	34-611	5/16-24	4-3/4"	Open Body
34-603	5/16-24	5-1/4"	Tubular	34-612	3/8-24	5-1/4"	Open Body
34-604	5/16-24	5-1/4"	Tubular-Slotted	34-613	1/2-20	6-1/2"	Open Body
34-605	3/8-24	5-1/2"	Tubular	34-614	5/8-18	7-3/4"	Open Body
34-606	3/8-24	5-1/2"	Tubular-Slotted	34-607-2	1/2-20	7"	Tubular
34-607	1/2-20	7"	Tubular-Slotted	34-608-2	5/8-18	8-1/2"	Tubular
34-608	5/8-18	8-1/2"	Tubular-Slotted				



Use for Life Line or Rigging Applications.

**Turnbuckle / Deck Toggle Jaws T-316**

CAT. NO.	THREAD SIZE	STYLE	CAT. NO.	THREAD SIZE	STYLE
33-601*	10-32 R.H.	T TOGGLE	33-617	5/16-24R.H.	T TOGGLE
33-602*	10-32 L.H.	T TOGGLE	33-618	5/16-24 L.H.	T TOGGLE
33-615	1/4-28 R.H.	T TOGGLE	33-617-1	5/16-24 R.H.	DECK TOGGLE
33-616	1/4-28 L.H.	T TOGGLE	33-618-1	5/16-24 L.H.	DECK TOGGLE
33-605	1/4-28 R.H.	TOGGLE NUT	33-619	3/8-24 R.H.	T TOGGLE
33-606	1/4-28 L.H.	TOGGLE NUT	33-620	3/8-24 L.H.	T TOGGLE
33-607	5/16-24R.H.	TOGGLE NUT	33-611	1/2-20 R.H.	TOGGLE NUT
33-608	5/16-24 L.H.	TOGGLE NUT	33-612	1/2-20 L.H.	TOGGLE NUT
33-609	3/8-24 R.H.	TOGGLE NUT	33-613	5/8-18 R.H.	TOGGLE NUT
33-610	3/8-24 L.H.	TOGGLE NUT	33-614	5/8-18 L.H.	TOGGLE NUT
33-615-1	1/4-28 R.H.	DECK TOGGLE	33-603**	1/4-28 R.H.	BCKSTY ADJ.
33-616-1	1/4-28 L.H.	DECK TOGGLE	33-604**	1/4-28 L.H.	BCKSTY ADJ.
33-615S*	1/4-28 R.H.	SHORTIE			
33-616S*	1/4-28 L.H.	SHORTIE			

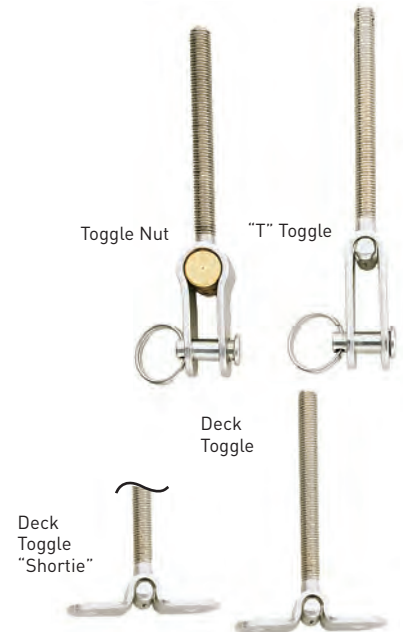

\* Also available in Deck Toggle Style.

\*\* For 01 Series Backstay Adjuster Only (Includes Square Nut)

All Toggle Jaws can be used for life line and rigging applications.  
Deck Toggles are used for Life line and Architectural applications only.

Use for Life Line or Rigging Applications.

**Locking Nuts**



CAT. NO.	THREAD SIZE	CAT. # USED ON	CAT. NO.	THREAD SIZE	CAT. # USED ON
35-601	10-32 R.H.	03 & 11	35-608	3/8-24 L.H.	06 & 08
35-602	10-32 L.H.	03	35-609	1/2-20 R.H.	General
35-603	1/4-28 R.H.	04 & 19	35-610	1/2-20 L.H.	General
35-604	1/4-28 L.H.	04, 19 & 21	35-611	5/8-18 R.H.	General
35-605	5/16-24 R.H.	05 & 07	35-612	5/8-18 L.H.	General
35-606	5/16-24 L.H.	05 & 07			
35-607	3/8-24 R.H.	06 & 08			

See full strength nuts on page 33 ARCHITECTURAL side of the catalog.

ALL TYPE 316 STAINLESS

Wire End Terminals for Machine Swaging

CAT. NO.	THREAD SIZE X LENGTH	WIRE SIZE	CAT # USED ON
32-604	10-32 L.H. x 1-7/8	1/16" †	03
32-605	10-32 L.H. x 1-7/8	3/32"	03 & 19
32-607	1/4-28 L.H. x 2-1/2	3/32"	04 & 19
32-608	1/4-28 L.H. x 2-1/2	1/8"	04 & 19
32-609	1/4-28 L.H. x 2-1/2	5/32"	04 & 19
32-610	1/4-28 R.H. x 2-1/2	3/32"	04(RH) & 42
32-611	1/4-28 R.H. x 2-1/2	1/8"	04(RH) & 42
32-612	1/4-28 R.H. x 2-1/2	5/32"	04(RH) & 42
32-613	10-32 R.H. x 3	1/16" †	11
32-614	10-32 R.H. x 3	3/32"	11
32-616	1/4-28 R.H. x 3 3/4	1/8"	12-104
32-617	1/4-28 R.H. x 3 3/4	5/32"	12-105
32-618	5/16-24 R.H. x 2 3/4	5/32"	05,07 & 43
32-619	5/16-24 R.H. x 2 3/4	3/16"	05,07 & 43
32-620	3/8-24 R.H. x 3	3/16"	06,08 & 44
32-621	3/8-24 R.H. x 3	7/32"	06,08 & 44
32-622	3/8-24 R.H. x 3	1/4"	06,08 & 44
32-626	1/2-20 R.H. x 3 1/2	1/4"	09/45
32-627	1/2-20 R.H. x 3 1/2	9/32"	09/45
32-628	1/2-20 R.H. x 3 1/2	5/16"	09/45
32-629	5/8-18 R.H. x 4 1/4	5/16"	10/47
32-630	5/8-18 R.H. x 4 1/4	3/8"	10/47

† Swage with 3/32" die

Wire End Terminals for Backstay Adjusters\*

CAT. NO.	THREAD SIZE X LENGTH	WIRE SIZE	CAT # USED ON
32-601	1/4-28 L.H. x 2-1/2	3/32"	01
32-602	1/4-28 L.H. x 2-1/2	1/8"	01
32-603	1/4-28 L.H. x 2-1/2	5/32"	01
32-623	3/8-24 R.H. x 4	3/16"	02
32-624	3/8-24 R.H. x 4	7/32"	02
32-625	3/8-24 R.H. x 4	1/4"	02

\* For Backstay Adjuster Only (1/4-28 Size Includes Square Nut)

EXTRA LONG Wire End Terminals for Machine Swaging

CAT. NO.	THREAD SIZE	WIRE SIZE	ADDED LENGTH
32-631	5/16-24 R.H.	5/32"	1-1/2"
32-632	5/16-24 R.H.	3/16"	1-3/4"
32-633	3/8-24 R.H.	3/16"	1-3/4"
32-634	3/8-24 R.H.	7/32"	2-1/4"
32-635	3/8-24 R.H.	1/4"	2-1/2"
32-636	1/2-20 R.H.	1/4"	2-1/2"



MACHINE  
MS  
SWAGE

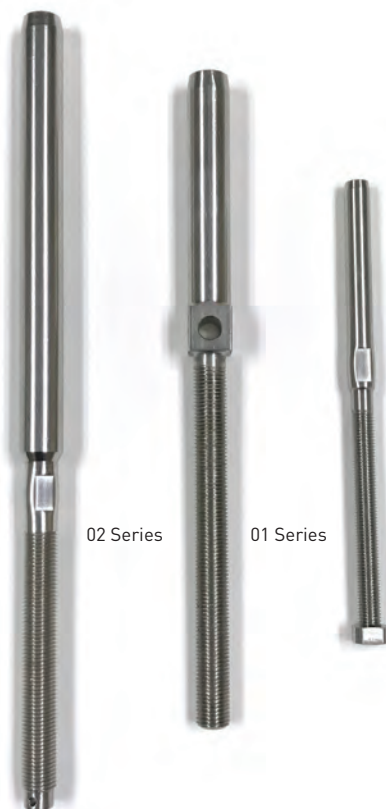

Extra Long

02 Series

01 Series

Techno•TIP

One of the most neglected parts on a sailboat are the Life Line and Rigging Turnbuckles. Turnbuckles need to be kept free of dirt and salt by rinsing with fresh water periodically. A good marine lubricant like Johnson Sealube or equivalent should be applied to the threads. The lubricant will provide corrosion protection and keep the turnbuckles turning freely. Never straighten a bent threaded stud, always replace, as a bent threaded stud has been weakened after bending.

**ALL TYPE 316 STAINLESS**

**Stainless Steel Clevis Pins**

\*Available in units of 100 Add -100 to CAT. NO. (Ex. CP-3-9-100)

**BLISTER PACKS**

(Complete with Pins\*)

CAT. NO.	DIA.	GRIP LGTH.	USAGE	CAT. NO. *	PCS/PACK
CP-3-9	3/16"	9/32"	Ser. 11 AN667-2,667-3	CPR-3-9-P	4
CP-3-13	3/16"	13/32"	Ser. 03 AN667-4	CPR-3-13-P	4
CP-3-17	3/16"	17/32"	Ser. 15	CPR-3-17-P	4
CP-3-32	3/16"	1"	Special	CPR-3-32-P	2
CP-4-13	1/4"	13/32"	AN667-5	CPR-4-13-P	4
CP-4-16	1/4"	1/2"	Ser. 01, 04, 19, 42 ETC.	CPR-4-16-P	4
CP-4-20	1/4"	5/8"	Special & 12-320	CPR-4-20-P	2
CP-4-24	1/4"	3/4"	Special	CPR-4-24-P	2
CP-4-40	1/4"	1-1/4"	Special	CPR-4-40-P	2
CP-5-18	5/16"	9/16"	Ser. 05, 07 AN667-6	CPR-5-18-P	2
CP-5-22	5/16"	11/16"	AN667-7	CPR-5-22-P	2
CP-5-24	5/16"	3/4"	Special & 12-321	CPR-5-24-P	2
CP-5-44	5/16"	1-3/8"	Special	CPR-5-44-P	2
CP-6-20	3/8"	5/8"	Ser. 06, 08 & 44	CP-6-20-P	2
CP-6-26	3/8"	13/16"	AN667-8	CP-6-26-P	2
CP-6-32	3/8"	15/16"	Special & 12-322	CP-6-32-P	1
CP-6-52	3/8"	1-5/8"	Special	CP-6-52-P	1
CP-7-28	7/16"	7/8"	AN667-9 & 10	CP-7-28-P	1
CP-7-40	7/16"	1-1/4"	Special & 12-326	CP-7-40-P	1
CP-7-52	7/16"	1-5/8"	Special	CP-7-52-P	1
CP-8-24	1/2"	3/4"	Ser. 09	CP-8-24-P	1
CP-8-32	1/2"	1"	AN667-12	CP-8-32-P	1
CP-8-40	1/2"	1-3/8"	Special & 12-323	---	---
CP-10-34	5/8"	1-1/16"	Ser. 10	CP-10-34-P	1
CP-10-40	5/8"	1-1/4"	Special	CP-10-40-P	1
CP-10-48	5/8"	1-1/2"	Special & 12-324	---	---
CP-12-48	3/4"	1-3/8"	Special & 12-325	---	---
CP-12-48-1	3/4"	1-7/8"	Special & 12-325	---	---

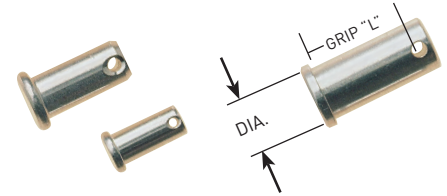

**Bronze Clevis Pins**



CAT. NO.	DIA.	GRIP LGTH.
CP-6-26B	3/8"	13/16"
CP-8-32B	1/2"	1"
CP-10-40B	5/8"	1-1/4"
CP-12-48B	3/4"	1-3/8"

\*CP - with Cotter Pins; CPR - with Ring Pins

**Circular Pins**

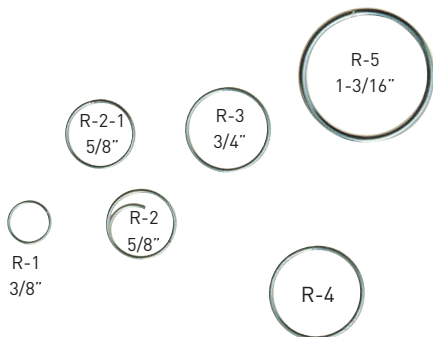

Sizes shown are I.D.

CAT. NO.	USAGE	QTY
R-1-100	For 3/16"	100
R-2-100*	3/16" & 1/4" Pins	100
R-2-1-100	3/16" & 1/4" Pins	100
R-3-100	1/4" & 3/8" Pins	100
R-5-100	1/2" & 5/8" Pins	100

**Circular Pins-Blister Pack**

CAT. NO.	USAGE	QTY
R-1-P	For 3/16"	20
R-2-P*	3/16" & 1/4" Pins	20
R-2-1-P	3/16" & 1/4" Pins	20
R-3-P	1/4" & 3/8" Pins	20
R-4-P	Large Pelican Hook	8
R-5-P	1/2" & 5/8" Pins	8

ALL TYPE 316 STAINLESS

### Stainless Steel Cotter Pins

\*Available in units of 100 Add -100 to CAT. NO. (Ex. C-2-2-100)

BLISTER PACKS



CAT. NO.	DIA. LENGTH	USAGE	CAT. NO.	PCS per PACK
C-2-2	1/16 X 1/2"		C-2-2-P	30
<b>C-2-2M</b>	<b>1/16 X 1/2"</b>		----	----
C-2-3	1/16 X 3/4"		C-2-3-P	22
C-2-4	1/16 X 1"		C-2-4-P	18
C-2-5	1/16 X 1-1/4"		C-2-5-P	14
C-2-6	1/16 X 1-1/2"		----	----
C-2-7	1/16 X 1-3/4"	3/16" and 1/4" Pins	----	----
C-3-3	3/32 x 3/4"		C-3-3-P	11
<b>C-3-3M</b>	<b>3/32 x 3/4"</b>		----	----
C-3-4	3/32 x 1"		C-3-4-P	9
C-3-5	3/32 x 1-1/4"		----	----
C-3-6	3/32 x 1-1/2"		C-3-6-P	7
C-3-8	3/32 x 2"		C-3-8-P	5
C-3-10	3/32 x 2-1/2"	5/16" and 3/8" Pins	----	----
C-4-4	1/8 x 1"		C-4-4-P	6
<b>C-4-4M</b>	<b>1/8 x 1"</b>		----	----
C-4-5	1/8 x 1-1/4"		----	----
C-4-6	1/8 x 1-1/2"		C-4-6-P	4
C-4-7	1/8 x 1-3/4"		----	----
C-4-8	1/8 x 2"		C-4-8-P	3
C-4-10	1/8 x 2-1/2"	7/16" and 1/2" Pins	----	----
C-5-5	5/32 x 1-1/4"		C-5-5-P	3
<b>C-5-5M</b>	<b>5/32 x 1-1/4"</b>		----	----
C-5-7	5/32 x 1-3/4"	5/8" and 3/4" Pins	C-5-7-P	2
C-5-8	5/32 x 2"		----	----
C-5-9	5/32 x 2-1/4"		C-5-9-P	2
C-5-10	5/32 x 2-1/2"		----	----
C-6-6	3/16 x 1-1/2"		C-6-6-P	2
C-6-10	3/16 x 2-1/4"	7/8" Pins	C-6-10-P	2
C-6-12	3/16 x 3"		----	----
SPECIAL POLYPACK COTTER PIN ASSORTMENT			C-A-P	26

NOTE: Available Monel Cotter Pins are highlighted in red

### Bronze Clevis Pins



CAT. NO.	DIA.	GRIP LGTH.
CP-6-26B	3/8"	13/16"
CP-8-32B	1/2"	1"
CP-10-40B	5/8"	1-1/4"
CP-12-48B	3/4"	1-3/8"

### Silicon Bronze Cotter Pins

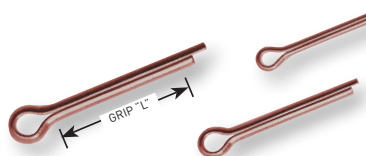

CAT. NO.	DIA. x Length	USAGE
C-3-3B	3/32 x 3/4"	5/16 and 3/8" Pins
C-4-4B	1/8 x 1"	7/16 and 1/2" Pins
C-5-5B	5/32 x 1-1/4"	5/8" Pins
C-6-6B	3/16 x 1-1/2"	3/4" Pins

ALL TYPE 316 STAINLESS

### Stainless Steel Rigging Pins

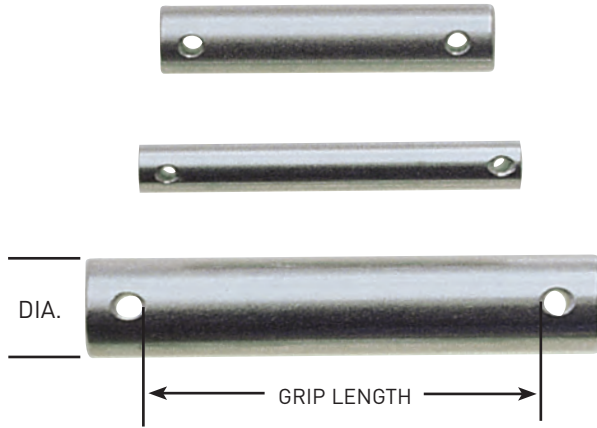

CAT. NO.	DIA.	GRIP LGTH
RP-4-1-1/2	1/4"	1-1/2"
RP-4-2	1/4"	2"
RP-4-2-1/2	1/4"	2-1/2"
RP-5-2	5/16"	2"
RP-5-3-1/2	5/16"	3-1/2"
RP-6-2	3/8"	2"
RP-6-2-5/8	3/8"	2-5/8"
RP-7-1-1/2	7/16"	1-1/2"
RP-7-2	7/16"	2"
RP-7-2-1/2	7/16"	2-1/2"
RP-8-2	1/2"	2"
RP-8-2-1/2	1/2"	2-1/2"
RP-8-3	1/2"	3"
RP-10-1-5/8	5/8"	1-5/8"
RP-10-2-1/2	5/8"	2-1/2"

ALL TYPE 316 STAINLESS

### Stainless Steel Quick Release Pins (Ball Type)

CAT. NO.	DIA.	GRIP LENGTH	USAGE
QR-3-20	3/16"	9/16"	15-212
QR-4-32	1/4"	1"	14-205(6)
QR-4-40	1/4"	1-1/4"	14-210 - 212
QR-6-26	3/8"	13/16"	02 Series
QR-8-32	1/2"	1"	46-501 - 501-2
QR-10-40	5/8"	1-1/4"	46-500 - 200-2

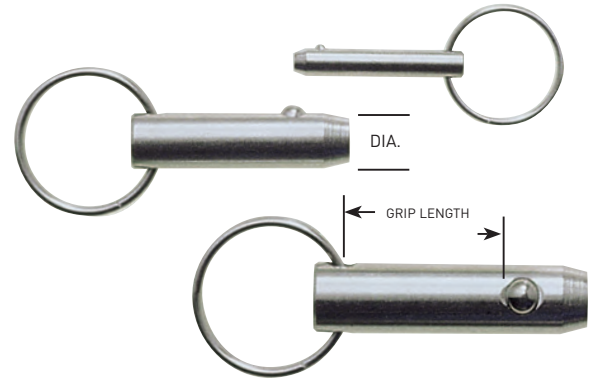

ALL TYPE 316 STAINLESS

### Locking Rings

Designed for use with Johnson Slotted Tubular Bodies. Will not work in Open Body Turnbuckles. Sold in pairs.

CAT. NO.	USAGE	BODY O.D.
36-601	07 Series	1/2"
36-602	08 Series	5/8"
36-603	09 Series	7/8"
36-604	10 Series	1"
36-605	04 Series	7/16"



### Safety Pins

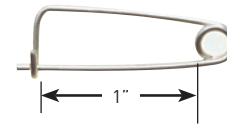

CAT. NO.	CAT. USAGE	PCS
SP-1	3/16 & 1/4" Pins	each
SP-1-P	3/16 & 1/4" Pins	10
SP-1-100	3/16 & 1/4" Pins	100

### Tubular Turnbuckle Adjustment Tool

This new tool features an easy to grasp handle.



CAT. NO.	DESCRIPTION
53-400	3/16" and 1/4" bodies
53-410	5/16", 3/8" and smooth line bodies

ALL TYPE 316 STAINLESS

### Rigging Toggles

These stainless steel rigging toggles are essential to prevent misalignment of rigid jaw turnbuckles. They are also used as a simple way to save rigging that was made too short. Ultimate strength exceeds the corresponding clevis pin. All sizes include pins.



CAT. NO.	A	B	C	D	E	F	G	SAFE WORKING LOAD
12-120	1/4"	1/4"	.094	5/16"	1"	5/16"	5/8"	1000 lbs
12-121	5/16"	5/16"	.094	19/64"	1-1/4"	11/32"	5/8"	1600 lbs
12-122	3/8"	3/8"	.141	23/64"	1-5/8"	13/32"	3/4"	2800 lbs
12-126	7/16"	7/16"	.165	27/64"	1-11/16"	15/32"	7/8"	3500 lbs
12-123	1/2"	1/2"	.187	31/64"	1-7/8"	17/32"	1"	4200 lbs
12-124	5/8"	5/8"	1/4"	39/64"	2-1/4"	11/16"	1-1/4"	5900 lbs
12-125	3/4"	3/4"	1/4"	47/64"	2-3/4"	13/16"	1-1/2"	9000 lbs

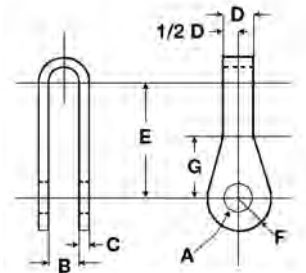

ALL TYPE 316 STAINLESS

### Double Jaw Toggles

Like our Eye Jaw toggles only used to facilitate toggling action when used with marine eyes and mechanical fittings. These toggles are available in 7 sizes from 1/4" - 3/4" pin sizes. All sizes include pins.

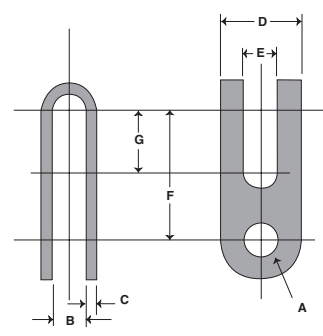

CAT. NO.	A	B	C	D	E	F	G	SAFE WORKING LOAD	Upper Replacement Washer	Upper Replacement Clevis Pin w/ Cotter
12-320	1/4"	1/4"	13GA	5/8"	1/4"	1-1/16"	1/2"	1000 lbs	320W	CP-4-20c
12-321	5/16"	5/16"	13GA	3/4"	5/16"	1-1/4"	5/8"	1600 lbs	321W	CP-5-24c
12-322	3/8"	3/8"	10GA	1"	3/8"	1-1/12"	3/4"	2800 lbs	322W	CP-6-34c
12-326	7/16"	7/16"	8GA	1-1/8"	7/16"	1-3/4"	7/8"	3500 lbs	326W	CP-7-40c
12-323	1/2"	1/2"	3/16"	1-1/4"	1/2"	2"	1"	4200 lbs	323W	CP-8-40c
12-324	5/8"	5/8"	1/4"	1-1/2"	5/8"	2-1/2"	1-1/4"	5900 lbs	324W	CP-10-48c
12-325	3/4"	3/4"	1/4"	1-3/4"	3/4"	3"	1-1/2"	9000 lbs	325W	CP-12-48-1c

# STA-LOK®

STA-LOK terminals are a simple mechanical method of terminating wire ropes. They offer a range of high quality, high performance fittings for 1 x 19, 7 x 7, 7 x 19 and Dyform wire ropes. The STA-LOK terminal produces 100% of the rated breaking strength of the wire rope and is approved by Lloyds Register of Shipping. All terminals are manufactured from polished T-316 stainless steel and are reusable (with new wedge).

Please note: Price includes the former and wedge. Each order must specify cable construction.



Fork Terminal



Stud Terminal



Eye Terminal

### FORK TERMINALS

CAT. NO.	WIRE SIZE	INSIDE W.	PIN SIZE
SL-F-4	1/8"	39/64"	3/16"
SL-F-5	5/32"	1/4"	1/4"
SL-F-6	3/16"	5/16"	5/16"
SL-F-7	7/32"	3/8"	7/16"
SL-F-8	1/4"	3/8"	7/16"
SL-F-9	9/32"	27/67"	7/16"
SL-F-10	5/16"	55/64"	1/2"
SL-F-12	3/8"	55/64"	5/8"

Larger sizes available - please inquire  
1/8" & 7/32" sizes will not work on 7x cables

### STUD TERMINALS: RH UNF

CAT. NO.	WIRE SIZE	THREAD SIZE	THREAD LGTH
SL-S-4	1/8"	1/4"	2-1/32"
SL-S-5	5/32"	5/16"	2-1/32"
SL-S-6	3/16"	5/16"	2-1/8"
SL-S-6B	3/16"	3/8"	2-5/8"
SL-S-7	7/32"	3/8"	2-5/8"
SL-S-8	1/4"	3/8"	2-5/8"
SL-S-8B	1/4"	1/2"	3-1/4"
SL-S-9	9/32"	1/2"	3-1/4"
SL-S-10	5/16"	1/2"	3-1/4"
SL-S-12	3/8"	5/8"	3-3/4"

Larger sizes available - please inquire  
1/8" & 7/32" sizes will not work on 7x cables

### EYE TERMINALS

CAT. NO.	WIRE SIZE	PIN SIZE
SL-E-4	1/8"	1/4"
SL-E-5	5/32"	5/16"
SL-E-6	3/16"	3/8"
SL-E-7	7/32"	3/8"
SL-E-8	1/4"	3/8"
SL-E-8B	1/4"	1/2"
SL-E-9	9/32"	1/2"
SL-E-10	5/16"	1/2"
SL-E-12	3/8"	5/8"

Larger sizes available - please inquire  
1/8" & 7/32" sizes will not work on 7x cables

*Use with Stud Terminals* →

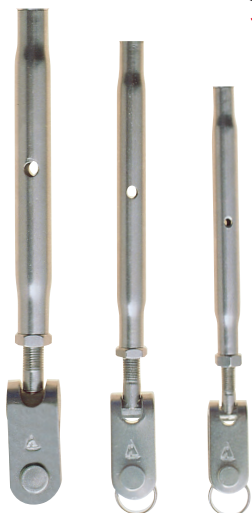

**NOW MATE YOUR STA-LOK STUD TO A JOHNSON TURNBUCKLE!**  
(Open Bodies also available - Right or Left Hand Jaws)

### 2/3 TURNBUCKLES WITH LEFT HAND JAW

CAT. NO.	THREAD SIZE	PIN SIZE	STYLE
04-60	1/4"	1/4"	Closed
05-60	5/16"	5/16"	Closed
06-50	3/8"	3/8"	Closed
09-50	1/2"	1/2"	Closed
10-50	5/8"	5/8"	Closed

Additional styles available - please inquire.



Backstay Insulator

### BACKSTAY INSULATORS For 1x19 Cable Only

CAT. NO.	WIRE SIZE	BREAK STRENGTH	LGTH
SL-BI-7	7/32"	9000 lbs.	7-1/2"
SL-BI-8	1/4"	9000 lbs.	7-1/2"
SL-BI-9	9/32"	15000 lbs.	8"
SL-BI-10	5/16"	15000 lbs.	8"
SL-BI-12	3/8"	219000 lbs.	9"

Larger sizes available - please inquire.

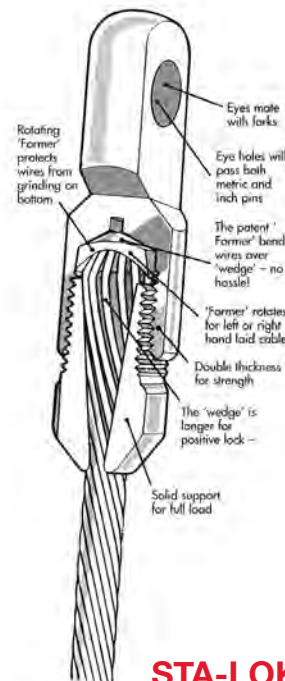

**STA-LOK®**

Johnson has a full line of boating accessories to make your boating safer and easier...



Add-A-Cleat  
Pg 61



Mast Boot  
Tape  
Pg 56



Shroud  
Cleat  
Pg 58



Anchor Tensioner  
Pg 57



Folding Pad Eye  
Pg 59



Toe Rail Mounted  
Folding Cleat  
Pg 58



Rigging Tape  
Pg 56



Sole Mate  
Pg 62



Rolling Furling  
Fairleads  
Pg 61



Wrap Pins  
pg 56



Roller Fairlead  
w/Twist  
Pg 61



ALL TYPE 316 STAINLESS

### Grab 'n GO Hook

#### Mooring Quick Connect/Disconnect System

This innovative quick connect/disconnect system allows you to easily pick up and release your mooring with your boat hook. Simply attach the slide hook to the end of your boat hook with the supplied clamp and the Grab 'n GO is easily connected and ready for use. Boat Hook and Line not included. Safe Working Load = 600 lbs.

Grab 'N Go	Cat. No. 48-750
Mount Only with Clamp	Cat. No. 48-701

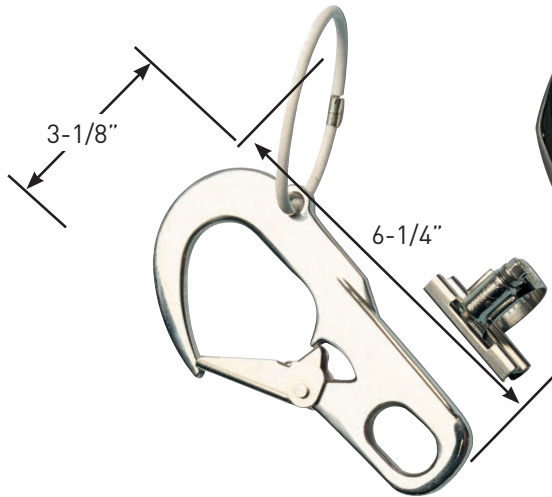

Max Line Diameter - 3/4"

#### Easy to Use...

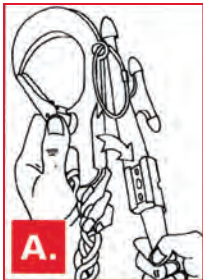

**A.** Attach your line to eye of Grab 'n GO and slide into track attached to your boat hook.



**B.** Position Grab 'n GO over eye of mooring and push down to engage with right hand while steadying line with left hand.



**C.** Pull boat hook away and allow Grab 'n GO to slide from boat hook.



**D.** Removal: Pull the pull loop with boat hook and disengage Grab 'n GO hook. TRY IT...it's EASY!



Attach Directly to Mooring Ball



Connect to chain or mooring line eye



Also works great on boat launch and retrieval too!

### Wrap Pins™ Hook and Loop Pin Locking Devices for Open Body Turnbuckles

Wrap pins are neat hook and loop locking devices used to secure turnbuckles without messing with unruly cotter pins. Just make your adjustment, push the pin attached to the hook and loop through the hole and wrap the hook and loop strip around the turnbuckle body. Works on open body turnbuckles and Johnson's positive locking, slotted tubular turnbuckles. Three sizes work on 1/4"-1/2" threaded turnbuckles. Order by thread diameter.



CAT. NO.	DESCRIPTION
WRAPC2-P	Pair 1/16" dia. for 1/4" threads
WRAPC2-20	20 Pack 1/16" dia. for 1/4" threads
WRAPC3-P	Pair 3/32" dia. for 5/16" & 3/8" threads
WRAPC3-20	20 Pack 3/32" dia. for 5/16" & 3/8" threads
WRAPC4-P	Pair 1/8" dia. for 7/16", 1/2" & 5/8" threads
WRAPC4-20	20 Pack 1/8" dia. for 7/16", 1/2" & 5/8" threads



### Johnson Riggers Grade Rigging & Mast Boot Tape - by Rubbaweld®



Johnson has brought back the self-amalgamating rigging tape that started the craze in the 70's. Our tape works well at covering up those exposed cotter pins or any sharp objects that may harm sails, lines or people. When used as directed, the tape actually bonds to itself and makes one solid piece. Can also be used on hot objects for an emergency repair on radiator hoses, etc. Rigging tape is sold in black or white 1" wide by 15' long and in a 4" wide by 10' long white mast boot tape. All sizes are packaged in a reusable, retail clamshell pack with color header and instructions

CAT. NO.	DESCRIPTION
50-115	1" x 15' rigging tape, WHITE
50-115B	1" x 15' rigging tape, BLACK
50-405	4" X 10' mast boot tape, WHITE

Case sizes available at quantity discount.

ALL TYPE 316 STAINLESS

### “Captain Hook” Chain Snubber

Our “Captain Hook” Chain Snubber can be used a few different ways:

1. Use the claw and attached line to relieve tension from your windlass while anchored by snubbing the chain overboard and tying off the line to a cleat or samson post on deck.
2. Use the snubber on deck for security to hold the chain in your anchor roller and tying off on a cleat while under way for piece of mind.
3. Relieve the tension on the windlass (like in 1) by attaching the snubber to the chain in the anchor roller and pulling back and tying off securely.

All T-316 stainless. Versions with 3-strand nylon line include professional eye splice.

NOTE: Always keep bitter end of anchor chain secure in windlass while using chain snubber.



CAT. NO.	DESCRIPTION
46-465	Small Snubber Hook for 1/4 & 5/16" Chain with 12' of 1/2" 3 Strand Nylon
46-465-5	Small Snubber Hook Only (5/16" T-316 SS stock)
46-475	Large Snubber Hook for 3/8" & 1/2" Chain with 15' of 5/8" 3 Strand Nylon
46-475-5	Large Snubber Hook Only (1/2" T-316 SS stock)

ALL TYPE 316 STAINLESS

### Anchor Chain Tensioners

These fitting will securely tension and hold the anchor in the bow roller channel. They will free up use of the bow cleat and prepare the anchor for sea condition assuring you peace of mind. This fitting is not designed to take the strain of the rode of a boat at anchor. “Single Hook” style has an overall length is 12”, the threaded hook has 1½” of adjustment for ease of installation.

Our new “Claw Hook” design features a shorter overall length than our current design and a “devils claw” type hook. The new claw design will grab 1/4”, 5/16” and 3/8” chain. The toggled claw enables you to grab the chain quickly and easily. Two 1/4” mounting holes are provided in the base of the unit and the claw has 1-1/2” of finite adjustment. The overall length closed is adjustable between 11” and 13” with a 2-1/8” throw or quick release. The handle/lever is secured when closed with a ball type QR pin attached with a lanyard.



Single Hook Style



Claw Hook Style

CAT. NO.	DESCRIPTION
46-250-1	Single-Hook Tensioner for 5/16" Chain
46-250-2	Single-Hook Tensioner for 3/8" Chain
46-450	Claw-Hook Tensioner for 1/4", 5/16" and 3/8" Chain

ALL TYPE 316 STAINLESS

### Toe Rail Folding Cleat

The toe rail folding cleat makes a perfect movable, mid-ship cleat for spring lines, etc. This cleat is mountable on all aluminum toe rails. The rail is protected by a silicon rubber pad for rattle free installation. The cleat folds out of the way when not in use, the husky 3/8" dia. cleat assures strength. The complete unit is T-316 stainless. Fits most symmetric and asymmetric aluminum toe rails.

Safe Working Load = 2000 lbs.



Toe Rail Folding Cleat

Cat. No. 48-510

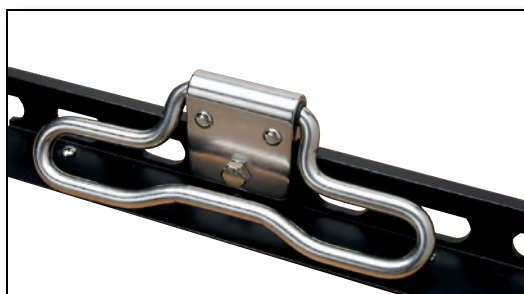

### Shroud Cleat

All stainless steel construction, compatible with your stainless steel rigging. Will not corrode. The JOHNSON SHROUD CLEAT is easily attached to 5/32" thru 3/8" dia. wire or rod. Ideal for flag, radar reflector and steaming shape halyards with an eye for attaching a snap shackle. Low profile, projects only 1/2" from shroud.



Shroud Cleat

Cat. No. 40-518



### Life Line Stanchion Brace

Our stanchion brace is welded and polished T-316 stainless steel with a collar to accept 1" diameter stanchions on a 60 degree angle. The base has a single hole for a 1/4" fastener. The brace should be used when adding a gate where no brace currently exists.



Cat. No. 40-200

ALL TYPE 316 STAINLESS

### Hinged Pad Eyes

Johnson Pad Eyes folds flat when not in use. The eyes gives with the load unlike rigid pad eyes; materially reducing the load on the fastenings. A friction drag insures that the eye stays in position and is rattle free. T-316 Stainless Steel construction. Supplied with backing plate.



1/4" Hinged Pad Eye	Cat. No. 48-580
5/16" Hinged Pad Eye	Cat. No. 48-585
3/8" Hinged Pad Eye	Cat. No. 48-590
1/2" Hinged Pad Eye	Cat. No. 48-595



### Mini 3/16" Hinged Pad Eye

This pad eye is a smaller version of our popular #48-580 hinged pad eye. This unit is suitable for awnings and many other tie down applications. Working load should not exceed 400 lbs. Material is all T-316 stainless. Fastens with (2) 1/4" bolts (not supplied).

3/16" Hinged Pad Eye	Cat. No. 48-570
----------------------	-----------------

### Pad Eye Dimensions

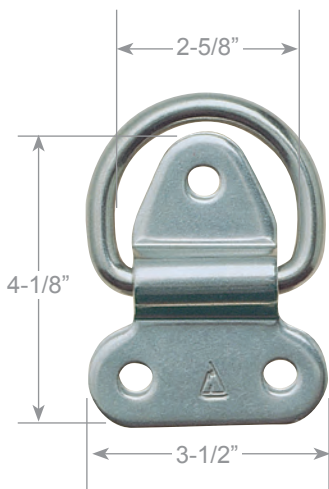

1/2" Hinged Pad Eye  
Safe Working Load: 3500 lbs

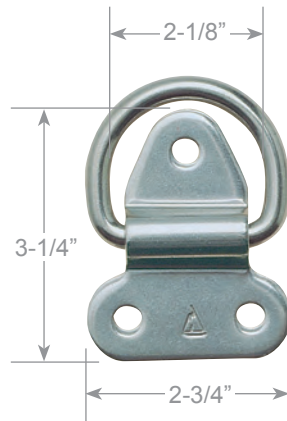

3/8" Hinged Pad Eye  
Safe Working Load: 2500 lbs



5/16" Hinged Pad Eye  
Safe Working Load: 1500 lbs

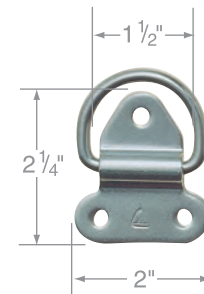

1/4" Hinged Pad Eye  
Safe Working Load: 1000 lbs



3/16" Hinged Pad Eye  
Safe Working Load: 400 lbs

ALL TYPE 316 STAINLESS

### 40 Series Mounting Bracket

Our 40 series base bracket will fit round rails 7/8" – 1" with the supplied clamp and fit up to 1-1/2" rails with a larger clamp. This extremely versatile fitting can be mounted vertically or horizontally. Use it to mount: Solar panels, drink holders and other accessories on your boat. The two outer holes are tapped for 10-32 fasteners on 1" center and the middle hole has a clearance for 1/4" fasteners.

40 Series Mounting Bracket      Cat. No. 40-5-2



### Rail Mount Roller Furling Fairlead with a Twist

We have added a 360 degree swivel feature to our popular furling fairlead in s/s bushed version. This fitting can be used in areas where articulation is required, reducing friction in the system.

Rail Mount Furling Fairlead      Cat. No. 40-503



### Roller Furling Fairlead

This versatile fitting may be mounted on stanchion or base from \* 7/8" to 1" diameter and allows control line to be located either inside or outside of stanchions. The fitting is easily installed and eliminates the need of drilling holes. Fairleads are available with either a phenolic bull's-eye or bushed for wire.

\*Will accommodate larger sizes with longer clamp.

Phenolic Bull's-eye      Cat. No. 40-501  
 S.S. Bushed Bull's-eye      Cat. No. 40-502



ALL TYPE 316 STAINLESS

### Roller Furling Bail

This fitting compliments our 40-501/502 fairlead. It easily mounts to stanchion or base from \* 7/8" to 1" diameter and will receive your favorite block, swivel or fixed eye. Use for final lead at cockpit and at bow if lead is severe.

\*Will accommodate larger sizes with longer clamp.

Roller Furling Bail

Cat. No. 40-505



Roller Furling Bail with Block attached

### Rotation Plate

This plate allows 45° of rotation in either vertical or horizontal plane. The plate mounts between the bracket and accessory unit on any of our "40" series mounts.



Rotation Plate

Cat. No. 40-513-4

### Add-A-Cleat

A versatile cleat easily mounts to a stanchion or rail \*7/8" and 1" diameter. Construction consists of a husky stainless steel bracket and clamp with a 4 1/2" nylon coated aluminum cleat. Use them for fenders and flag halyards. Installation is easily made with a screwdriver.

\*Will accommodate larger sizes with longer clamp.

Add-A-Cleat

Cat. No. 40-506





**Flag Halyard Kit**  
**Spreader Halyard Kit**

Everything you need to rig a spreader flag halyard. 40 ft. of 3/16" polyester line, block with wire rope clamp, cleat with wire rope clamp and (2) bronze snaps. Easily attaches to 5/32" thru 3/8" Dia. wire or rod. Includes 40 ft. of polyester line, block with bail and shroud cleat.

Spreader Halyard Kit	Cat. No. 40-530
----------------------	-----------------

**Sealube - Turnbuckle Lubricant**

Space age synthetic lubricant especially formulated for turnbuckles or any high bearing load, low speed application. Will carry higher bearing loads than any other lubricant. Provides powerful resistance to corrosion of the host metal. Water resistant and long lasting.



1 oz. bottle	Cat. No. 48-540
Case/24 bottles	Cat. No. 48-541

**Sole Mate - Ladder Treads**

Comfortable foot pads easily installed on your stern swim ladder. No cutting, drilling or fitting. Made of no maintenance ABS plastic in a wood tone with stainless steel mounting hardware.



Install in pairs on each step or alternately. For welded ladders made of 1" diameter tubing only. 5" long.

Ladder Tread	Cat. No. 48-560
Ladder Tread Pair	Cat. No. 48-561



## PIN AND PARTS KITS

### Cotter, Ring and Clevis Pin Parts Kit

Cat. No. 37-503



#### Kit Contents

CATALOG #	DESCRIPTION	QUANTITY
CP-3-9	Clevis Pin, Dia. 3/16", Grip 9/32"	30 Pack
CP-3-13	Clevis Pin, Dia. 3/16", Grip 13/32"	30 Pack
CP-3-17	Clevis Pin, Dia. 3/16", Grip 17/32"	10 Pack
CP-4-13	Clevis Pin, Dia. 1/4", Grip 13/32"	6 Pack
CP-4-16	Clevis Pin, Dia. 1/4", Grip 1/2"	30 Pack
CP-5-18	Clevis Pin, Dia. 5/16", Grip 9/16"	6 Pack
CP-5-22	Clevis Pin, Dia. 5/16", Grip 11/16"	6 Pack
CP-6-20	Clevis Pin, Dia. 3/8", Grip 5/8"	2 Pack
CP-6-26	Clevis Pin, Dia. 3/8", Grip 13/16"	6 Pack
CP-7-28	Clevis Pin, Dia. 7/16", Grip 7/8"	2 Pack
CP-8-24	Clevis Pin, Dia. 1/2", Grip 3/4"	1 Pack
CP-8-32	Clevis Pin, Dia. 1/2", Grip 1"	2 Pack
R-2	Circular Pins, 3/16" & 1/4"	50 Pack
SP-1	Safety Pins, 3/16" & 1/4"	10 Pack
C-2-2	Cotter Pin, 1/16"x1/2"	100 Pack
C-3-3	Cotter Pin, 3/32"x3/4"	50 Pack
C-4-4	Cotter Pin, 1/8"x1"	25 Pack
C-5-5	Cotter Pin, 5/32"x1 1/4"	10 Pack

### Small Boat Kit

Cat. No. 37-504



#### Kit Contents

CATALOG #	DESCRIPTION	QUANTITY
CP-3-17	Clevis Pin Dia. 3/16" GL 17/32"	6
CP-4-16	Clevis Pin Dia. 1/4" GL 1/2"	6
CP-5-22	Clevis Pin Dia. 5/16" GL 11/16"	4
R-2	Circular Pin 3/16" & 1/4" w/ Starter	10
C-3-3	Cotter Pins 3/32" x 3/4" Type 316SS	10
SP-1	Safety Pin 3/16" & 1/4"	6

### Custom Kits

Cat. No. 37-Cus

Planning an owners rendezvous, special club event or anytime you may require a personalized pin kit? Any quantities ok, just let us know what the kit will contain, and what the top label is to say and JOHNSON can make it happen. Call for further information and pricing.



ALL TYPE 316 STAINLESS

## INDUSTRIAL FITTINGS AND TURNBUCKLES



Google Campus - Mountain View, CA  
Fabricator: Duvall Design Inc., West Rockport, ME

### Hinged Pad Eyes

Johnson Pad Eyes folds flat when not in use. The eyes gives with the load unlike rigid pad eyes; materially reducing the load on the fastenings. A friction drag insures that the eye stays in position and is rattle free. T-316 Stainless Steel construction. Supplied with backing plate.

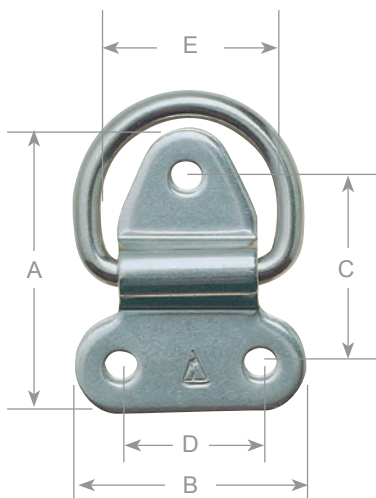

### Hinged Mini Pad Eye

Catalog No. 48-570

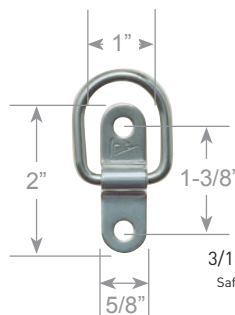

3/16" Hinged Pad Eye  
Safe Working Load: 400 lbs

CAT. NO.	SAFE WORKING LOAD	A	B	C	D	E	F
48-580	1,000 LBS	2-1/4"	2"	1-1/2"	1-1/4"	1-1/2"	1/4"
48-585	1,500 LBS	3"	2-1/2"	2"	1-1/2"	2"	5/16"
48-590	2,500 LBS	3-1/4"	2-3/4"	2-1/8"	1-5/8"	2-1/8"	3/8"
48-595	3,500 LBS	4-1/8"	3-1/2"	2-5/8"	2"	2-5/8"	1/2"

### Eye-to-Hook Stainless T-316 Tubular Turnbuckles

Check Nut Locking with welded, wire formed eye.

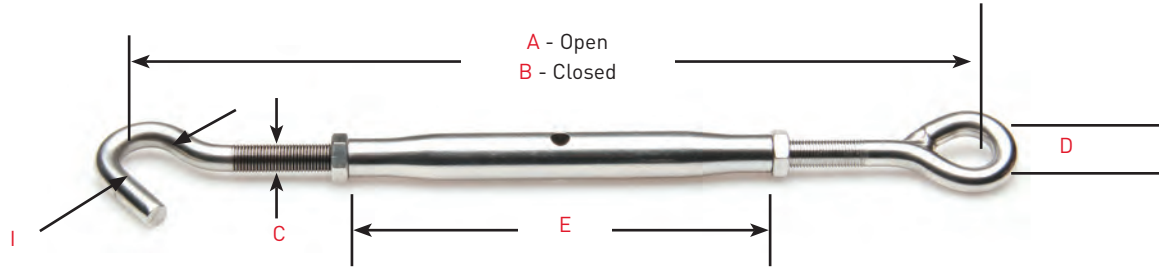

CAT. NO.	TYPE	*SAFE WORKING LOAD	A LENGTH OPEN	B LENGTH CLOSED	C THREAD SIZE	D EYE ID	E BODY LENGTH	I HOOK OPENING	WT. lb oz
03-610	Eye/Hook	85 lbs.	8-3/4"	6-1/4"	10-32	5/16"	3-1/2"	1/4"	3
04-610	Eye/Hook	195 lbs	10-1/4"	7-1/4"	1/4-28	3/8"	4-1/2"	3/8"	5
05-610	Eye/Hook	290 lbs.	11-1/2"	8-3/4"	5/16-24	1/2"	5-1/8"	1/2"	8
06-610	Eye/Hook	405 lbs.	13"	9"	3/8-24	5/8"	5-3/8"	5/8"	14
09-610	Eye/Hook	770 lbs.	15-1/2"	10-3/4"	1/2-20	3/4"	7"	3/4"	2 0
10-610	Eye/Hook	1,235 lbs.	18"	13"	5/8-18	7/8"	8-5/8"	7/8"	4 0

\*These values are based on an open hook design which are not heat-treated or forged.

### Hook-to-Hook Stainless T-316 Tubular Turnbuckles

Check Nut Locking

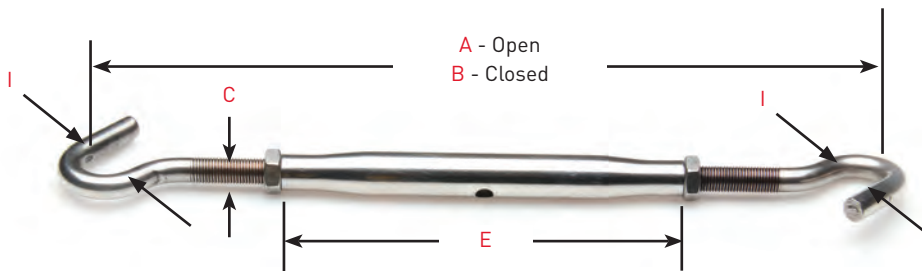

CAT. NO.	TYPE	*SAFE WORKING LOAD	A LENGTH OPEN	B LENGTH CLOSED	C THREAD SIZE	E BODY LENGTH	I HOOK OPENING	WT. lb oz
03-655	Hook/Hook	85 lbs.	9"	6-1/2"	10-32	3-1/2"	1/4"	3
04-655	Hook/Hook	195 lbs	10-1/2"	7-1/2"	1/4-28	4-1/2"	3/8"	5
05-655	Hook/Hook	290 lbs.	11-3/4"	9"	5/16-24	5-1/8"	1/2"	8
06-655	Hook/Hook	405 lbs.	13-1/2"	9-3/4"	3/8-24	5-3/8"	5/8"	14
09-655	Hook/Hook	770 lbs.	15-3/4"	11"	1/2-20	7"	3/4"	2 0
10-655	Hook/Hook	1,235 lbs.	18-1/2"	13-1/2"	5/8-18	8-5/8"	7/8"	4 0

\*These values are based on an open hook design which are not heat-treated or forged.

ALL TYPE 316 STAINLESS

### Eye-to-Eye T-316 Stainless Tubular Turnbuckles

Check Nut Locking with welded, wire formed eyes.

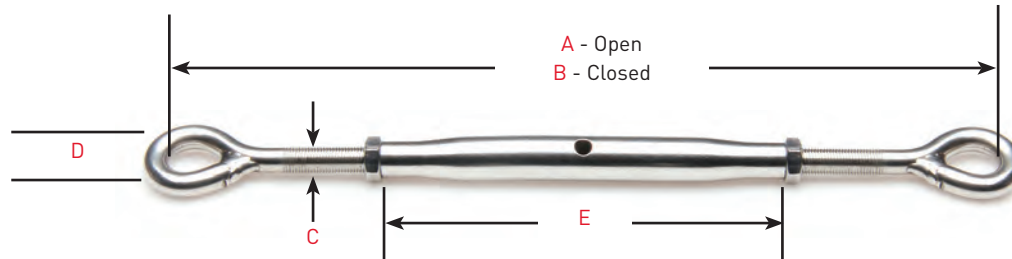

CAT. NO.	TYPE	APPROX. BREAKING STRENGTH	SAFE WORKING LOAD	A LENGTH OPEN	B LENGTH CLOSED	C THREAD SIZE	D EYE I.D.	E BODY LENGTH	WT. lb oz
03-155	Eye/Eye	1,000 lbs.	400 lbs.	8-1/2"	6"	10-32	5/16"	3-1/2"	3
04-155	Eye/Eye	2,500 lbs.	1000 lbs.	10"	7"	1/4-28	3/8"	4-1/2"	5
05-155	Eye/Eye	4,000 lbs.	1600 lbs.	11-1/4"	8-1/2"	5/16-24	1/2"	5-1/8"	8
06-155	Eye/Eye	7,000 lbs.	2800 lbs.	12-3/4"	8-3/4"	3/8-24	5/8"	5-3/8"	14
09-155	Eye/Eye	10,500 lbs.	4200 lbs.	15-1/4"	10-1/2"	1/2-20	3/4"	7"	20
10-155	Eye/Eye	14,800 lbs.	5900 lbs.	17-3/4"	12-3/4"	5/8-18	7/8"	8-5/8"	40

### Eye-to-Jaw T-316 Stainless Tubular Turnbuckles

Check Nut Locking with welded, wire formed eye.

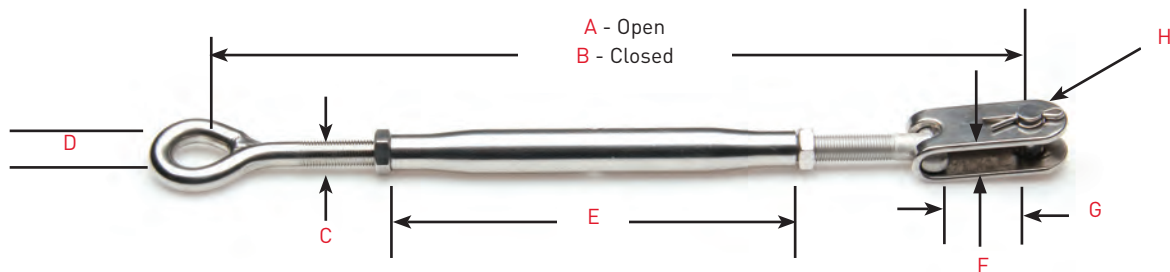

CAT. NO.	TYPE	APPROX. BREAKING STRENGTH	SAFE WORKING LOAD	A LENGTH OPEN	B LENGTH CLOSED	C THREAD SIZE	D EYE I.D.	E BODY LENGTH	F JAW OPENING	G JAW THROAT	H PIN DIA	WT. lb oz
03-150	Eye to Jaw	1,000 lbs.	400 lbs.	9"	6-1/2"	10-32	5/16"	3-1/2"	3/16"	3/4"	3/16"	3
04-150	Eye to Jaw	2,500 lbs.	1000 lbs.	10-1/2"	7-1/2"	1/4-28	3/8"	4-1/2"	1/4"	4/4"	1/4"	5
05-150	Eye to Jaw	4,000 lbs.	1600 lbs.	11-3/4"	9"	5/16-24	1/2"	5-1/8"	5/16"	1"	5/16"	8
06-150	Eye to Jaw	7,000 lbs.	2800 lbs.	13-1/2"	9-3/4"	3/8-24	5/8"	5-3/8"	3/8"	1-1/8"	3/8"	14
09-150	Eye to Jaw	10,500 lbs.	4200 lbs.	15-3/4"	11"	1/2-20	3/4"	7"	1/2"	1-1/16"	1/2"	20
10-150	Eye to Jaw	14,800 lbs.	5900 lbs.	18-1/2"	13-1/2"	5/8-18	7/8"	8-5/8"	5/8"	1-3/8"	5/8"	40

### Hook-to-Jaw Stainless T-316 Tubular Turnbuckles

Check Nut Locking

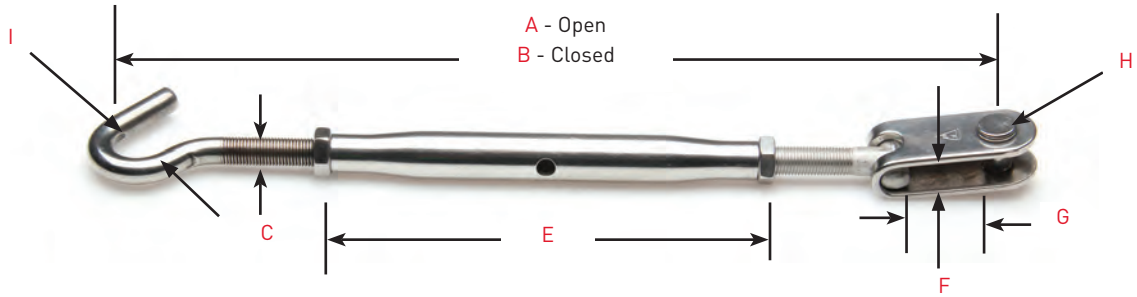

CAT. NO.	TYPE	*SAFE WORKING LOAD	A LENGTH OPEN	B LENGTH CLOSED	C THREAD SIZE	E BODY LENGTH	F JAW OPENING	G JAW THROAT	H PIN DIA	I HOOK OPENING	WT. lb oz
03-650	Hook/jaw	85 lbs.	9-1/4"	6-3/4"	10-32	3-1/2"	3/16"	3/4"	3/16"	1/4"	3
04-650	Hook/jaw	195 lbs.	10-3/4"	7-3/4"	1/4-28	4-1/2"	1/4"	3/4"	1/4"	3/8"	5
05-650	Hook/jaw	290 lbs.	12"	9-1/4"	5/16-24	5-1/8"	5/16"	1"	5/16"	1/2"	8
06-650	Hook/jaw	405 lbs.	13-3/4"	10"	3/8-24	5-3/8"	3/8"	1-1/8"	3/8"	5/8"	14
09-650	Hook/jaw	770 lbs.	16"	11-1/4"	1/2-20	7"	1/2"	1-1/16"	1/2"	3/4"	2 0
10-650	Hook/jaw	1,235 lbs.	18-3/4"	13-3/4"	5/8-18	8-5/8"	5/8"	1-3/8"	5/8"	7/8"	4 0

\*These values are based on an open hook design which are not heat-treated or forged.

### Jaw-to-Jaw Stainless T-316 Tubular Turnbuckles

Check Nut Locking

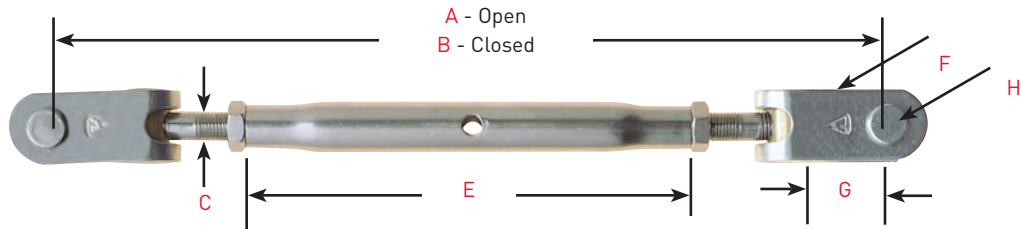

CAT. NO.	TYPE	APPROX. BREAKING STRENGTH	SAFE WORKING LOAD	A PIN TO PIN LENGTH OPEN	B PIN TO PIN LENGTH CLOSED	C THREAD SIZE	E BODY LENGTH	F JAW OPENING	G JAW THROAT	H PIN DIA	WT. lb oz
03-110**	Jaw/Jaw	1,000 lbs	400 lbs.	6-3/8"	8-7/8"	10-32	3-1/2"	3/16"	3/4"	3/16"	2.5
04-100	Jaw/Jaw	2,500 lbs.	1000 lbs.	8"	11"	1/4-28	4-1/2"	1/4"	3/4"	1/4"	5
04-110**	Jaw/Jaw	2,500 lbs.	1000 lbs.	8"	11"	1/4-28	4-1/2"	5/16"	1"	1/4"	5
04-110S**	Jaw/Jaw	2,500 lbs.	1000 lbs.			1/4-28		3/8"	1-1/8"	1/4"	5
05-110**	Jaw/Jaw	4,000 lbs.	1600 lbs.	9"	12-3/4"	5/16-24	5-1/8"		1-1/16"	5/16"	1 8
06-110**	Jaw/Jaw	7,000 lbs.	2800 lbs.	9-1/2"	13-3/4"	3/8-24	5-5/8"	5/8"	1-3/8"	3/8"	3 14
09-100-2	Jaw/Jaw	10,500 lbs.	4200 lbs.	12"	16-3/4"	1/2-20	7"	3/8"		1/2"	1 12
10-100-2	Jaw/Jaw	14,800 lbs.	5900 lbs.	14"	19"	5/8-18	8-5/8"	7/8"		5/8"	3 10

\*\*Jaw with "T" Toggle Construction. All others have bronze toggle nuts to prevent galling under high load conditions.

# Johnson

C. SHERMAN JOHNSON CO. INC.

A tradition of innovation for over 60 years.



Please come see us at major Boat Shows!  
We exhibit at several shows around the country and Europe.



JOHNSON MARINE products are manufactured in the United States. All secondary machining, finishing, design, testing, assembly, inspection, warehousing and shipping as well as sales and marketing takes place from our East Haddam, CT facility.



Our shop and warehouse in East Haddam, CT has recently been expanded to better serve you!



## C. SHERMAN JOHNSON COMPANY INC.

Manufacturers of Architectural and Marine Hardware

East Haddam Industrial Park • East Haddam Connecticut 06423

Phone: 860/873-8697 • Fax: 860/873-8589

Visit our website: [www.csjohnson.com](http://www.csjohnson.com)

e-mail: [info@csjohnson.com](mailto:info@csjohnson.com)

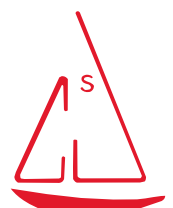

## MARINE FACTORY REPRESENTATIVES

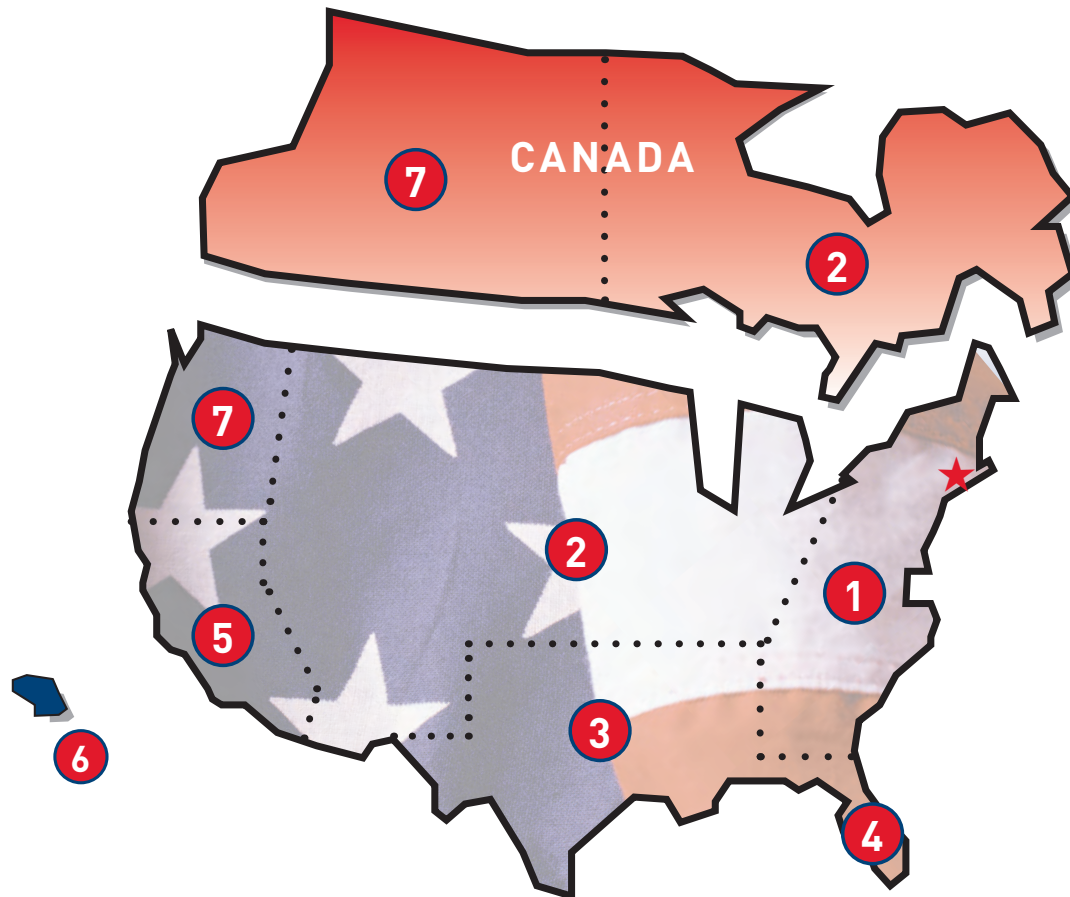

**1 New England, Mid-Atlantic and NC, SC & GA**  
**COMMAR SALES, LLC**  
 1445 Main Rd.  
 Tiverton, RI 02878  
 800/343-7979  
 Email: info@commar.com  
 www.commar.com

**2 House Territory**  
 Contact Johnson Marine

**3 Gulf Coast**  
 Peter Waters  
 (AL, AR LA, MS, OK, TX)  
**WATERS & DAVID**  
 82 Hampson St. Ste. 300  
 New Orleans, LA 70118  
 504/533-8484  
 Email: office@watersanddavid.com

**4 Florida**  
 Tom Rinda  
**EAST COAST MARINE MARKETING**  
 1315 40th Avenue  
 St. Petersburg, FL 33703  
 727/525-0598  
 CELL 727/560-6365  
 Email: mercofl@aol.com

**5 West Coast**  
 Bruce Brown (Southern, CA)  
**BRUCE BROWN & ASSOC.**  
 2825 Club House Rd.  
 Costa Mesa, CA 92626  
 714/299-5951  
 FAX 714/435-9265  
 Email: b2brown51@att.net

Kirk Brown (Northern CA)  
**BRUCE BROWN & ASSOC.**  
 6219 Monita Street  
 Long Beach, CA 90803  
 562/598-7157  
 kirk@sterling-industrial.com

**6 Hawaiian Islands**  
**MICHAEL D. MORELLI**  
 33 Kalaka Place  
 P. O. Box 811  
 Kailua, HI 96734-0811  
 808/262-2777  
 FAX 808/262-2775  
 Email: farwest@hawaii.rr.com

**7 Pacific Northwest & Western Canada**  
 Rick Collier  
**PACIFIC FOCUS MARKETING**  
 756 NE Haugen St.  
 Poulsbo, WA 98370  
 360/509-2250  
 FAX 877/289-3448  
 email: rcollierpf@gmail.com